



Technology for Vacuum Systems

## Instructions for use



**CVC 2''**

**Vacuum controller**

Dear customer,

Your VACUUBRAND controller should support you for a long time without trouble and with maximal power. Thanks to our long practical experience we have much information how you could ensure powerful application and personal safety. Please read these instructions for use before the initial operation of your controller. VACUUBRAND controllers are the result of many years of experience in construction and practical operation of these controllers combined with the latest developments in material and manufacturing technology.

Our quality maxim is the "zero fault principle":

Every controller leaving our company is tested intensively including an endurance run. Therefore also faults, which occur rarely, are identified and can be eliminated immediately.

The achievement of the specifications after the endurance run is tested for every controller.

**Every VACUUBRAND controller achieves the specifications. We feel obliged to this high quality standard.**

We know that the controller can not take a part of your real work and hope that our products contribute to an effective and trouble-free realisation of your work.

Yours

VACUUBRAND GMBH + CO KG

**After sales service: Contact your local dealer or call +49 9342 808-193.**

# Contents

<b>Safety information!</b> .....	<b>4</b>
<b>Technical data</b> .....	<b>6</b>
<b>Description</b> .....	<b>7</b>
<b>General view basic setups</b> .....	<b>9</b>
<b>How to work with the controller</b> .....	<b>10</b>
<b>General view basic setup "Standard"</b> .....	<b>11</b>
<b>Basic setup Standard</b> .....	<b>12</b>
<b>Vacuum management with VMS Module A</b> .....	<b>16</b>
<b>Basic setup Management or Management Plus</b> .....	<b>20</b>
<b>General view basic setup VACUU•LAN</b> .....	<b>22</b>
<b>Basic setup VACUU•LAN</b> .....	<b>23</b>
<b>How to determine the best distillation conditions</b> .....	<b>26</b>
<b>Installation and accessories</b> .....	<b>27</b>
<b>Troubleshooting</b> .....	<b>29</b>
<b>Readjustment</b> .....	<b>31</b>
<b>Calibration in the factory</b> .....	<b>32</b>
<b>Notes on return to the factory</b> .....	<b>33</b>
<b>Health and safety clearance form</b> .....	<b>34</b>



**Attention! Important notes!**



**Not permitted! Misuse may cause damage.**



**Caution! Hot surface!**



**Isolate equipment from mains.**



**Note.**



## Safety information!



Remove all packing material, remove the product from its packing-box, remove the protective covers and keep, inspect the equipment.

If the equipment is damaged, notify the supplier and the carrier in writing within three days; state the item number of the product together with the order number and the supplier's invoice number. Retain all packing material for inspection.

**Do not use the equipment if it is damaged.**

If the equipment is not used immediately, replace the protective covers. Store the equipment in suitable conditions.

☞ **Read and obey this manual before installing or operating the equipment.**

Use the equipment for the intended use only (for measurement and control of vacuum). Operate the controller only in combination with VACUUBRAND genuine accessories (e. g. isolation valve, vacuum management module VMS A). Make sure that the individual components are only connected, combined and operated according to their design and as indicated in the instructions for use.

☞ Obey notes on correct vacuum and electrical connections, see section "Use and operation".

☞ Make sure that the individual components are only connected, combined and operated according to their design and as indicated in the instructions for use.



Obey **national safety regulations and safety requirements** concerning the use of vacuum and electrical equipment.

☞ Equipment must be connected only to a suitable fused and protected electrical supply and a suitable earth point. Failure to connect the device to ground may result in deadly electrical shock.

☞ The supply cable may be fitted with a moulded European IEC plug or a plug suitable for your local electrical supply. If the plug has been removed or has to be removed, the cable will contain wires colour coded as follows: green or green and yellow: earth; blue or white: neutral; brown or black: live.

☞ Check that mains voltage and current conform with the equipment (see rating plate).

☞ If the equipment is brought from cold environment into a room for operation, allow the equipment to warm up (pay attention to water condensation on cold surfaces).

☞ Make sure ventilation is adequate if the equipment is installed in a housing or if ambient temperature is elevated.

☞ The controller is equipped with a short circuit proof transformer with an integrated overload protection (no fuses).



Obey all **relevant safety requirements** (regulations and guidelines) and adopt suitable safety measures.

☞ **Max. permitted pressure at the controller: 1.5 bar (absolute).**

To the best of our knowledge the equipment is in compliance with the requirements of the applicable EC-directives and harmonized standards with regard to design, type and model, especially directive IEC 1010. This directive gives in detail conditions, under which the equipment can be operated safely (see also IP degree of protection).

☞ Adopt suitable measures in case of differences, e. g. using the equipment outdoors, installation in altitudes of more than 1000 m above mean sea level, conductive pollution or dewiness.



Do not permit any **uncontrolled pressurizing** (e. g. make sure that system pipelines cannot become blocked).

☞ Avoid overpressure of more than 0.2 bar in case inert gas is connected.



Adopt suitable measures to prevent dangers arising from **dangerous or explosive gases** and dangers arising from the formation of **explosive fluids or explosive or flammable mixtures** and ensure that the materials of the wetted parts are compatible, see section "Technical data".

- ☞ Adopt suitable measures to prevent the release of dangerous, explosive, corrosive or polluting fluids.
- ☞ Use inert gas for venting if necessary.
- ☞ Take adequate precautions to protect people from the effects of dangerous substances, wear appropriate safety-clothing and safety glasses.
- ☞ Position the device in the vacuum system so as to avoid flow of condensate towards the pressure transducer inside the device.



Electronic equipment is never 100% fail-safe. This may lead to an indefinite status of the equipment. Provide protective measures against malfunction and failure.

- ☞ Operating the isolation or cooling water valve or the pump (in combination with VMS Module A) must not lead to a critical dangerous situation under any circumstances.

Use only **genuine spare parts and accessories**.

- ☞ Otherwise safety and performance of the equipment as well as the electromagnetic compatibility of the equipment might be reduced.



Ensure that maintenance is done only by suitably trained and supervised technicians. Ensure that the maintenance technician is familiar with the safety procedures which relate to the product processed by the vacuum system and that the equipment, if necessary, is appropriately decontaminated before starting maintenance.

Obey local and national safety regulations.

Before starting maintenance vent the system, isolate the components from the vacuum system and the electrical supply.

Before starting maintenance, wait two minutes after isolating the equipment from mains to allow the capacitors to discharge.

In order to comply with law (occupational, health and safety regulations, safety at work law and regulations for environmental protection) vacuum pumps, components and measuring instruments returned to the manufacturer can be repaired only when certain procedures (see section "Notes on return to the factory") are followed.

## Technical data

Controller	CVC 2 <sup>II</sup>
Pressure transducer	integrated piezoresistive absolute pressure transducer, with anticorrosion design
Display	analog and digital LCD display
Pressure units/scale (to be switched between)	mbar, Torr or hPa
Measuring range	1300 mbar - 1 mbar (975 Torr - 1 Torr)
Control range (absolute)	1060 mbar - 1 mbar (795 Torr - 1 Torr)
Accuracy (after careful adjustment and at constant temperature)	<+/-2 mbar (1.5 Torr)
Temperature coefficient	<+/- 0.2 mbar/K (0.15 Torr/K)
Long term zero shift (due to temperature variation)	<+/- 4 mbar (3 Torr)
Max. temperature of gaseous media	for short periods up to 80°C
Ambient temperature range (operation)	+0°C to +40°C
Ambient temperature range (storage)	-10°C to +70°C
Mains supply (see rating plate)	110 V~ +/-15% / 50-60 Hz 230 V~ +/-10% / 50-60 Hz
Degree of protection IEC 529	IP 20
Power draw	max. 13 VA
Power out (male connector) designated for simultaneous operation (parallel connection) with the following original accessories:	- isolation valve VV 6C or VV 15C - water valve 24 V= - Vacuum Management System VMS A
Air admittance valve	elektromagnetic, integrated, with hose nozzle for inert gas supply (5 mm Ø)
Vacuum connection	stepped hose nozzle for vacuum hoses with 6-10 mm inside diameter
Mass	1.5 kg
Dimensions (L x W x H)	241 mm x 132 mm x 91 mm
Stand mounting (included)	screw in rod, Ø 1/2", thread M8

Components	Wetted parts
Vacuum connection	PPS, stainless steel
Seal	FPM
Sensor connecting tube	PVC
Sensor housing	Nickel-iron-alloy, gold-tin solder
Sensor	Gold, silicon

**We reserve the right for technical modification without prior note!**

## Description



Operating the controller is possible in four different basic setups, see "Changing the basic setup".

The status of the controller respectively of the connected accessories is displayed by corresponding symbols on the LCD. After switching on the controller, the **version of the software** is displayed, then the preselected basic setup. The solenoid operated isolation valve is switched if connected (automatic identification), the cooling water valve is switched, if the valve is configured.

### Display

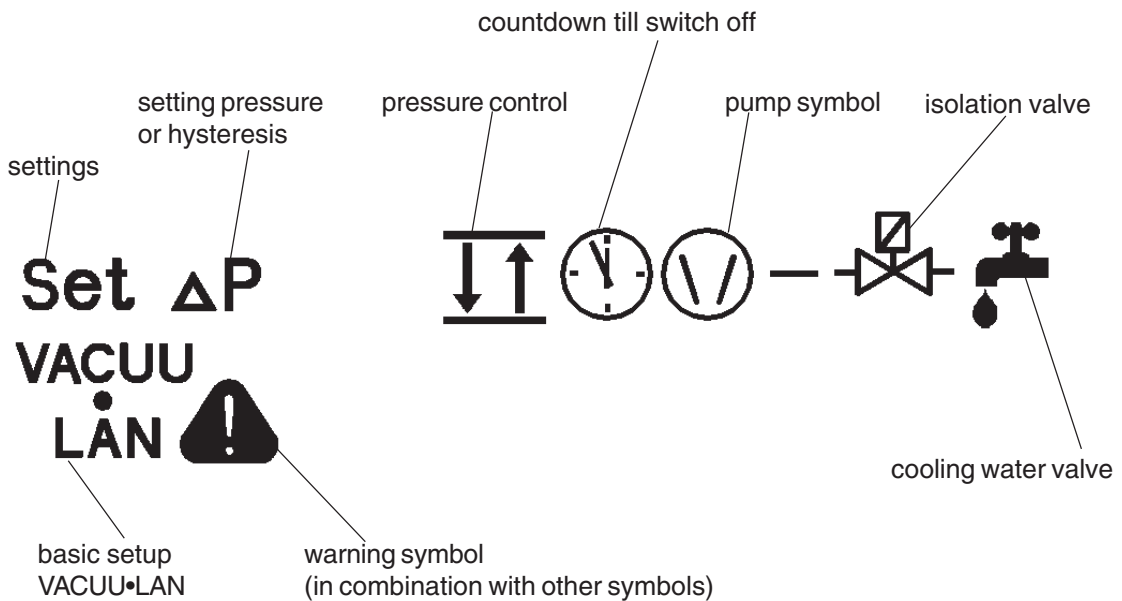

### Pressure reading

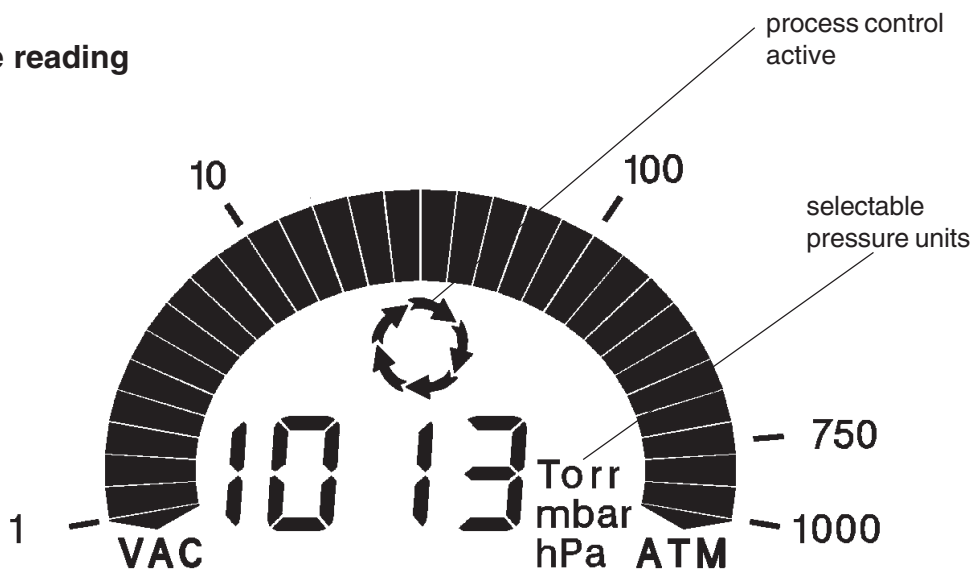

## Keys

- setting of set point  $p$
- switching in programs

- switching between two-switch-point control and continuous pumping
- special function (in combination with an additional key)

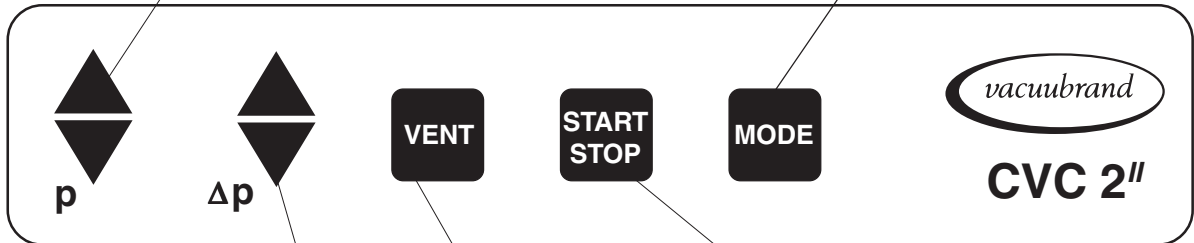

setting of hysteresis  $\Delta p$  or time  $t$  for switch-off

operating the built in air admittance valve

- start or stop of process control
- confirmation of selected values

## Rear side

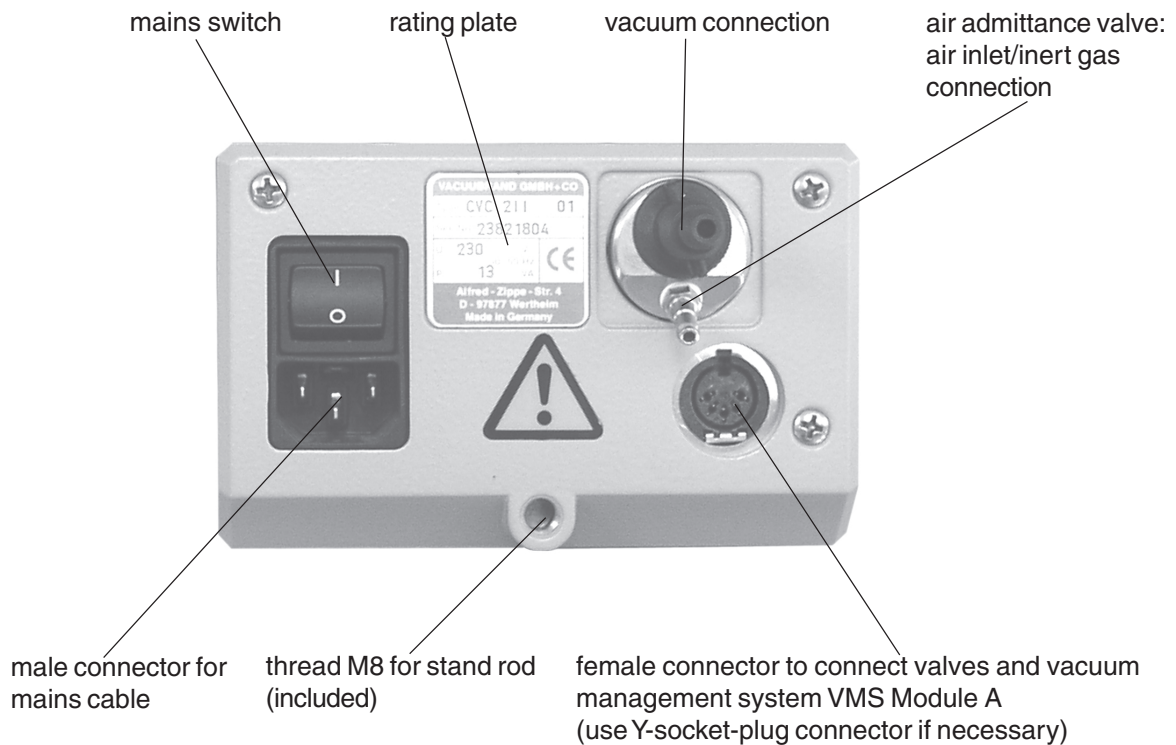



## General view basic setups

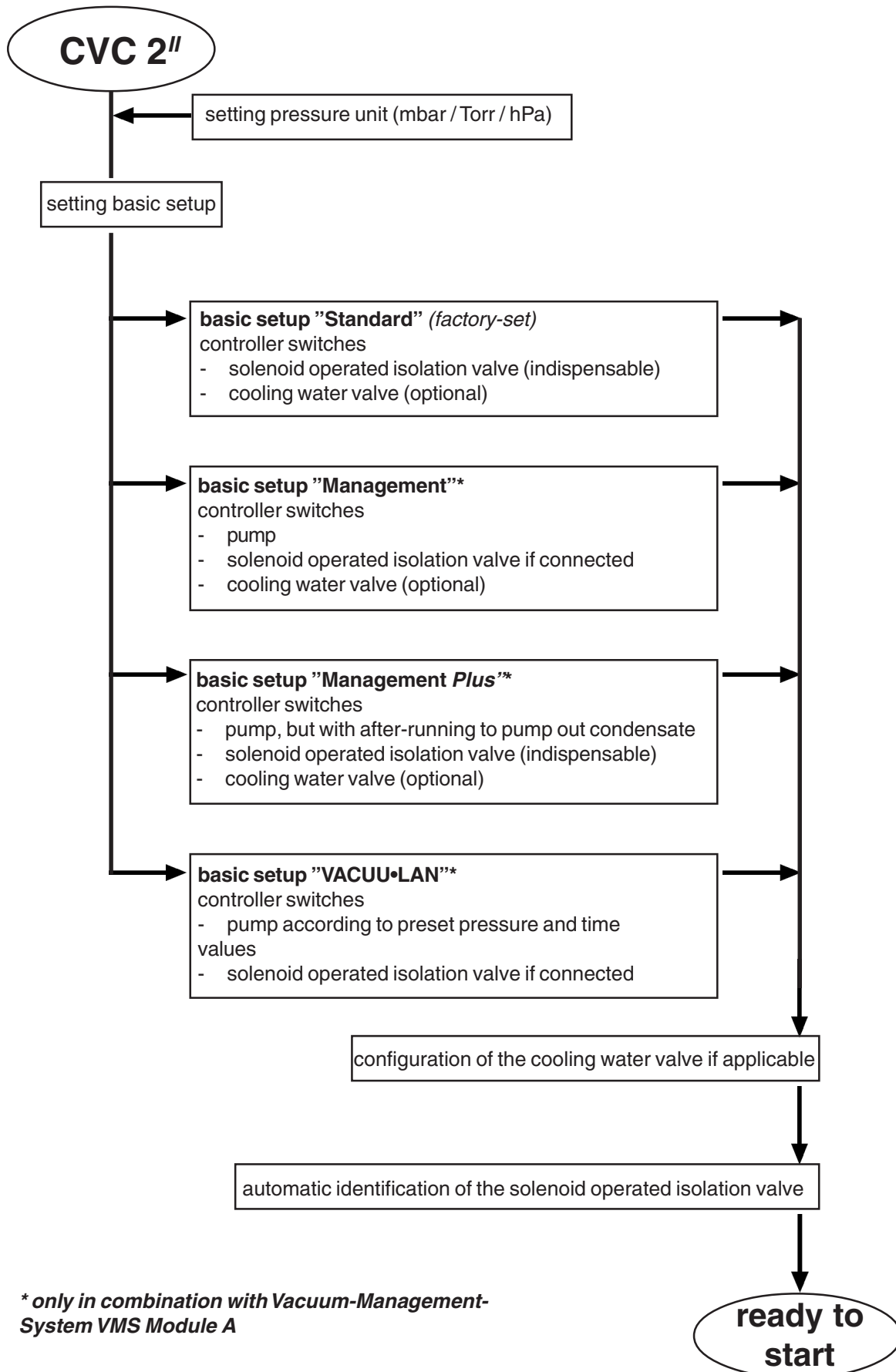

## How to work with the controller

### How to change the pressure units

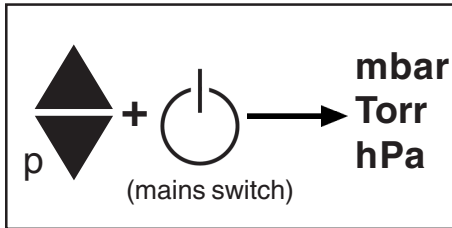

Press key p▲ or p▼ while switching on.

☞ The pressure units are displayed, the pressure unit as from last operation is flashing.

➔ Press key p▲ or p▼ to change pressure unit. Press key START/STOP to confirm and to finish the operation mode.

### Setting the cooling water valve (optional)

The controller switches a preselected cooling water valve.

A cooling water valve has to be configured at the controller before starting the process see section "Changing the basic setup".

It is possible to configure the **cooling water valve** in **all basic setups**, see scheme above.

## General view basic setup "Standard"

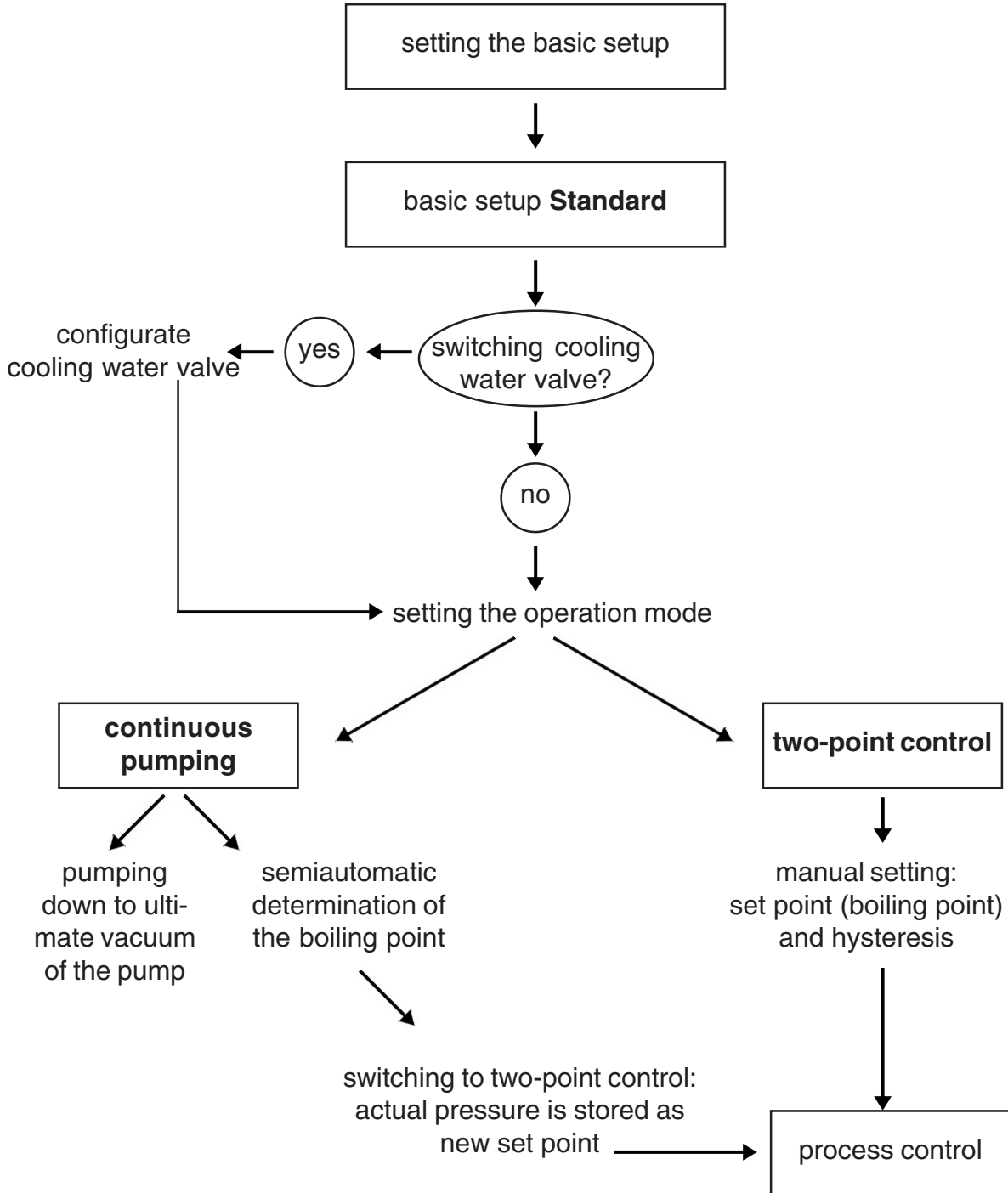

## Basic setup Standard

### After switching on

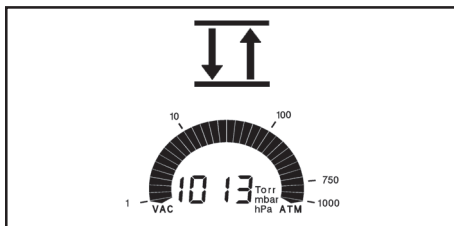

The process control is inactive, i. e. controller is ready for vacuum control, but control operation has not been activated.

- ☞ The controller is in operation mode two-point control, the actual pressure is displayed.
- ☞ Values for set point p and hysteresis as from last operation are reactivated.
- ☞ Press key START/STOP to start process control.

- ☞ If using a cooling water valve, the valve must be configured, see section "How to change the basic setup".

### Switching between two point control and continuous pumping

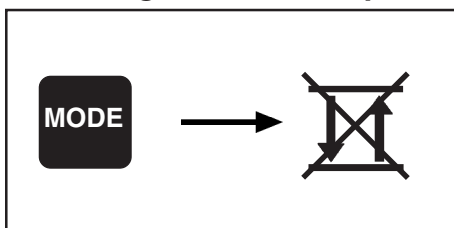

- ➔ Press key MODE.
- ☞ Mode change is only possible if the process control is inactive (after switching on or pressing key START/STOP).
- ☞ The two-point control display disappears or appears.

### Starting and stopping the process control

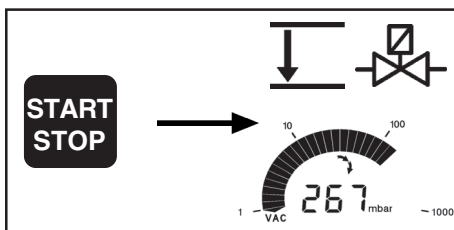

In both modes (two-point control and continuous vacuum):

- ➔ **To start** the process control: Press key START/STOP.
- ☞ If the cooling water valve is preselected: Cooling water valve opens immediately, the symbol is displayed.
- ☞ Isolation valve opens. If a cooling water valve is preselected, at the first demand of vacuum the isolation valve opens 2 sec. past the cooling water valve: Pumped vapour reaches cold surfaces of condenser.
- ➔ **To stop** the process control: Press key START/STOP.
- ☞ **Attention:** Take suitable precautions if the system risks to become pressurized due to low boiling point solvents when the isolation valve has been closed.
- ☞ If a cooling water valve is preselected: Cooling water continuous to run for additional 5 min. to allow condensation, symbol cooling water is flashing.

### Venting

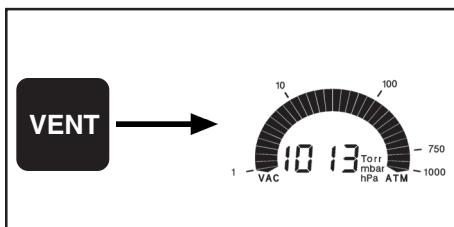

**Short venting** (e. g. in case of retardation of boiling or if sudden foaming occurs):

- ➔ Press key VENT shortly (< 2 sec.).
- ☞ Pumping is interrupted, the process control is stopped.

**Venting the system:**

- ➔ Press key VENT continuously (> 2 sec.).
- ☞ Pumping is interrupted, the process control is stopped.
- ☞ Ventilation until pressure does not change any more, i. e. until atmospheric pressure is attained
- ☞ Key STOP interrupts venting at any time.



**Attention: If pressurized inert gas is used install an overpressure relief valve. Max. pressure at the pressure transducer 1600 mbar! Ensure that high pressure is compatible with the mechanical stability of the system!**

## Continuous pumping

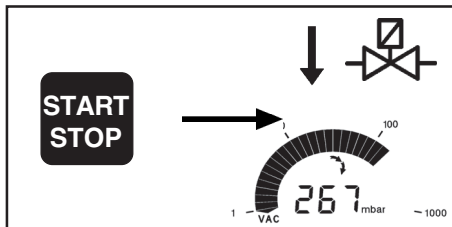
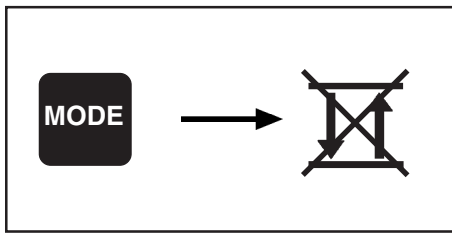

**Pumping down until the ultimate vacuum of the pump is attained** (e. g. pump down to dry the system from volatile liquids):

If the controller is in mode two-point control:

- ➔ Press key MODE to change to continuous pumping.
- ☞ Mode change is only possible if the process control is inactive.
- ☞ The two-point control display disappears.
- ➔ Start: Press key START/STOP.
- ☞ Arrow down and valve and/or pump symbol are flashing.
- ➔ Stop: Press key START/STOP.

## Two-point control

### Manual setting of set point p (boiling point)

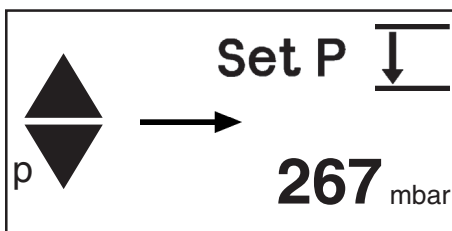

- ➔ Selecting the set point by using keys p▲ or p▼.
- ☞ Set mode is activated by pressing key shortly: Set p appears.
- ☞ Short tips toggle p in steps of 1 mbar.
- ☞ Continuous pressing activates ramp: set-point p changes with increasing speed.
- ☞ Changing set point p leads at the same time to an automatic preselection of hysteresis  $\Delta p$ .
- ☞ Hysteresis  $\Delta p$  can be manually changed at any time similar to p by using keys  $\Delta p$ , see "Manual setting of hysteresis  $\Delta p$ ".

### Manual setting of hysteresis $\Delta p$



- ➔ Set hysteresis  $\Delta p$  by using keys  $\Delta p$ ▲ or  $\Delta p$ ▼:
- ☞ Set mode is activated by pressing key shortly: Set  $\Delta p$  appears.
- ☞ Short tips toggle in steps of 1 mbar.
- ☞ Continuous pressing activates ramp: Hysteresis  $\Delta p$  changes with increasing speed.

### Semiautomatic determination of set point p (boiling point)

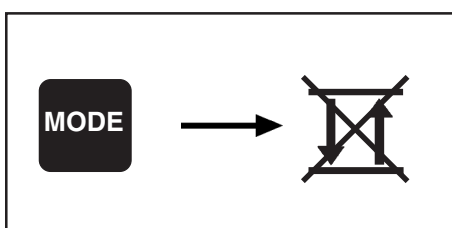

- ➔ Start continuous pumping.
- ☞ Switch over to continuous pumping by pressing key MODE if controller is in two-point control mode.
- ☞ Mode change is only possible if process control is inactive. Display two-point control disappears.

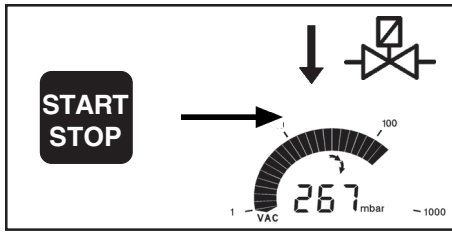

- Start: Press key START/STOP.
- ☞ Arrow down and valve and/or pump symbol are flashing: Supervise process permanently.

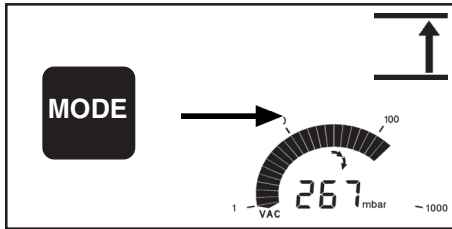

- When sufficient evaporation appears: Press key MODE.
- ☞ Continuous pumping is stopped. The actual pressure  $p$  is stored as new set point.
- ☞ Two-point control is activated with set point  $p$  and  $\Delta p$  as preprogrammed on the controller. Hysteresis  $\Delta p$  can be manually changed at any time.

### Changing the set point $p$ during process control



Changing the set point  $p$  upwards by using key  $p\blacktriangle$ :

- When the key is pressed shortly, the current pressure is displayed for one second.
- ☞ Continuous pressing or a second tip within one second: The air admittance valve is opened, the current pressure is displayed and stored as new set point when the key is released.
- ☞ Hysteresis  $\Delta p$  is adapted automatically only in case of great set point changes. Hysteresis  $\Delta p$  can be manually changed at any time.



Changing the set point  $p$  downwards by using key  $p\blacktriangledown$ :

- When the key is pressed shortly, the current pressure is displayed for one second.
- ☞ Continuous pressing or a second tip within one second: The isolation valve is opened, pump is switched on, the current pressure is displayed and stored as new set point when the key is released.
- ☞ Hysteresis  $\Delta p$  is adapted automatically only in case of great set point changes. Hysteresis  $\Delta p$  can be manually changed at any time.

Example basic setup **Standard:** PC 510 connected to a rotary evaporator

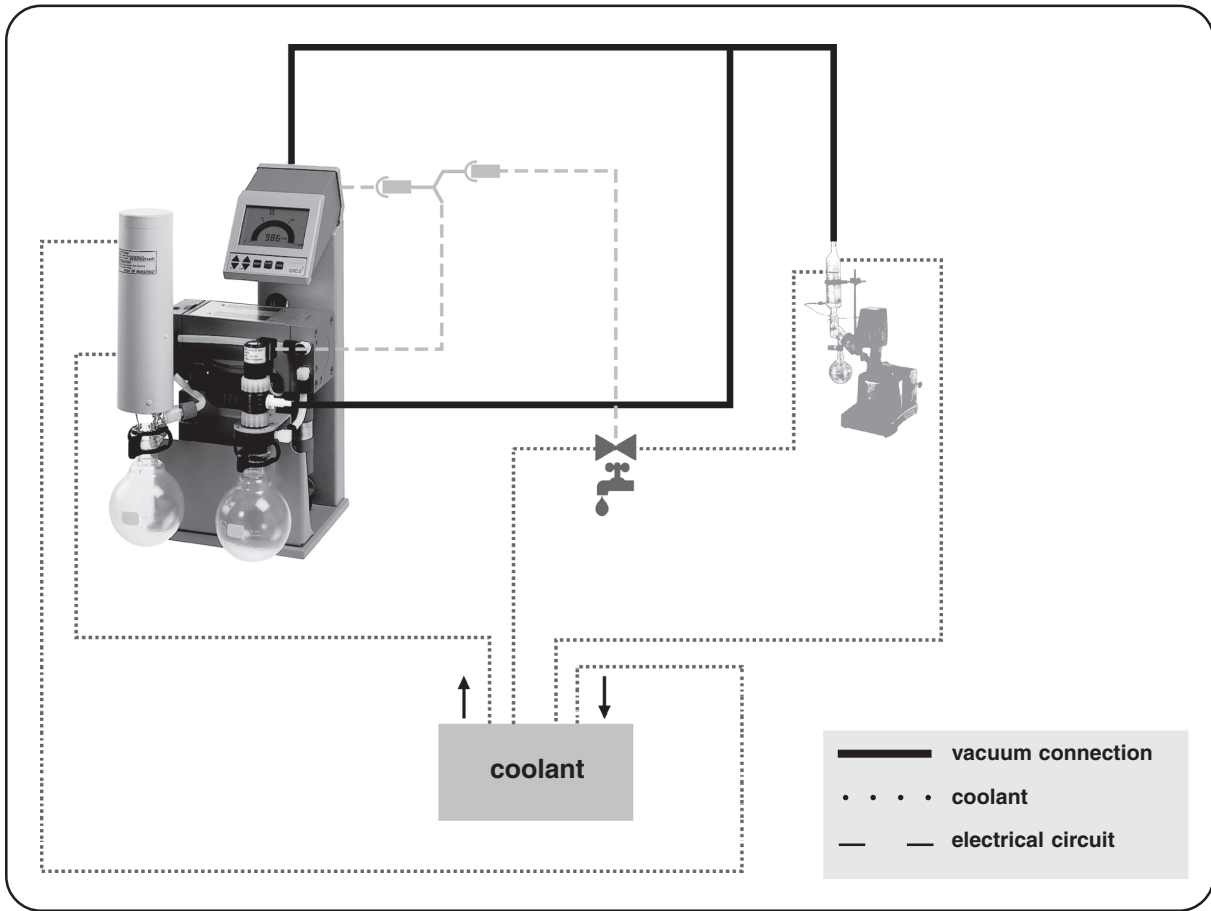

# Vacuum management with VMS Module A

## Notes on choosing the basic setup



The controller CVC 2<sup>II</sup> can be adapted to the specific application by choosing the appropriate basic setup **Standard**, **Management**, **Management Plus** or **VACUU•LAN** and choosing an operation mode, two-point control or continuous pumping: The connected components of the chemistry vacuum system have to be preset once only.

The vacuum controller CVC 2<sup>II</sup> offers four basic setups depending on

- the components of the VACUUBRAND chemistry vacuum system which are connected to the system.
- the specific user and/or process requirements.

The controller CVC 2<sup>II</sup> identifies automatically if an isolation valve is connected. If it is missing, the basic setups "Standard" and "Management Plus" are not selectable.

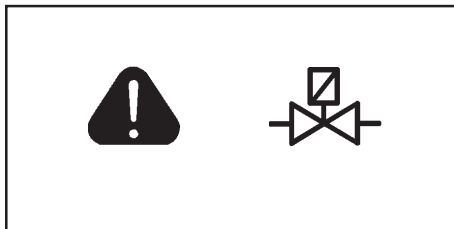

### Warning triangle and symbol isolation valve are flashing:

- ➔ Isolation valve is missing, is however indispensable for the selected basic setup.
- 🔊 Connect isolation valve or choose appropriate basic setup.

**Attention:** The basic setups **Management**, **Management Plus** or **VACUU•LAN** are selectable only if a **VMS Module A** and an isolation valve if necessary are connected!



connected components	desired operation	required accessories	basic setup
<p><i>one solenoid operated connection</i> <b>PC 510 / PC 610</b> (single user system)</p> <p><b>PC 610 / PC 611</b> (additional manual flow control valve)</p> <p><i>two solenoid operated connections</i> <b>PC 520 / PC 620</b></p>	<p>☞ switching the isolation valve only?</p> <p>☞ switching the pump only?</p> <p>☞ switching pump and isolation valve?</p>	<ul style="list-style-type: none"> <li>▪ —</li> <li>▪ VMS Module A</li> <li>▪ VMS Module A</li> </ul>	<p>➔ Standard</p> <p>➔ Management</p> <p>➔ Management <i>Plus</i></p>
<p><i>multiple user system with VACUU•LAN®</i> <b>PC 510 / PC 511 / PC 520 / PC 610 / PC 611 / PC 620</b></p>	<p>➔ <b>control at the pump</b></p> <p>☞ switching the isolation valve only?</p> <p>☞ switching the pump only?</p> <p>☞ switching pump and isolation valve?</p> <p>➔ <b>control at the pump and the vacuum connections?</b></p>	<ul style="list-style-type: none"> <li>▪ —</li> <li>▪ VMS Module A</li> <li>▪ VMS Module A</li> <li>▪ VMS Module A, additional vacuum controllers CVC 2<sup>II</sup> and isolation valves</li> </ul>	<p>➔ Standard</p> <p>➔ Management</p> <p>➔ Management <i>Plus</i></p> <p>➔ controller at the pumpe in setup VACUU•LAN®, controller at the vacuum connections in setup Standard</p>

## How to change the basic setup



Starting the program:

- Press key MODE while switching on the controller.
- ☞ The basic setup as from last operation (factory-set: Standard) is displayed.

To change the basic setup:

- Press key p▲ or p▼ until the symbols of the desired basic setup are displayed.
- Press key START/STOP to confirm the selected basic setup.

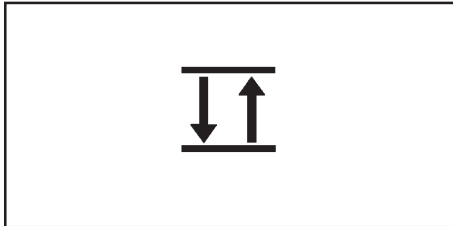

### Standard

- ☞ **An isolation valve is indispensable.**
- ☞ Dispenses the cooling water according to the requirements (cooling water valve 24 V= at the CVC 2").

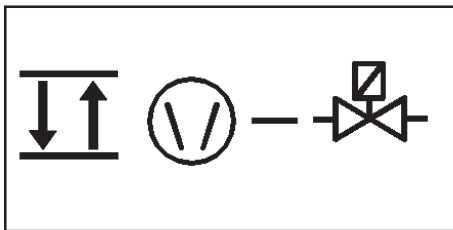

### Management

- ☞ **A VMS Module A is indispensable.**
- ☞ Process-orientated switching of the diaphragm pump in two-point control operation and in continuous operation.
- ☞ Dispenses the cooling water according to the requirements.
- ☞ The pump is operated parallel (synchronous) to the isolation valve.
- ☞ Energy consumption is reduced to a minimum.
- ☞ Operation is also possible without an isolation valve.

**Attention:** Take into account possible suck-back of gas (even though at a very low rate) through the not-operating pump, especially if the gas ballast valve is open. Make sure that no potentially inflammable mixtures can be formed!

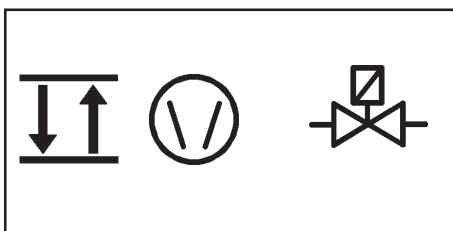

### Management Plus

- ☞ **An isolation valve and a VMS Module A are indispensable.**
- ☞ Dispenses the cooling water according to the requirements.
- ☞ Process-orientated switching of the diaphragm pump in two-point control operation and in continuous operation.
- ☞ High tolerance to condensates due to sufficient operation time even in interval operation.



### VACUU•LAN

- ☞ **A VMS Module A is indispensable.**
- ☞ The vacuum pump is switched according to the preset pressure and time values.
- ☞ The pump is switched off if no more pumping is required, the pump is switched on again in case of pressure rise.



After setting the basic setup:

- ☞ The symbol of the cooling water valve is displayed and "yes" or "no".
  - ➔ Press key p▲ or p▼ to activate ("yes") or to inactivate ("no") the cooling water valve and press key START/STOP to confirm.
  - ☞ The cooling water valve 24 V= at the controller is operated parallel (synchronous) to the cooling water valve at the VMS Module A.
- 
- ☞ The controller is now ready for operation (process control inactive).
  - ☞ The **isolation valve** is identified automatically.
  - ☞ If it is missing in basic setup Standard or Management *Plus*, the process control cannot be started, respectively is stopped.
  - ☞ If it is missing in basic setup Management or VACUU•LAN, the valve symbol is not displayed.

## Basic setup Management or Management *Plus*

Starting and stopping the process control, venting the system and the operation modes two-point control and continuous pumping are described in section "basic setup Standard".

If the cooling water valve is preselected, the cooling water valve opens immediately after starting the process control (the cooling water valve 24 V= at the controller is operated parallel (synchronous) to the cooling water valve at the VMS Module A), the according symbol is displayed.

### Basic setup Management:

The vacuum pump is switched off when the process control is stopped.

Attention: If working in basic setup Management without an isolation valve, air might enter the apparatus through the pump when it is switched off, especially if the gas ballast valve is open.



### Only basic setup Management:

- ☞ If the pump is switched frequently the warning triangle is flashing.
- ☞ Check system parameters, especially the selected value for  $\Delta p$ .

### Basic setup Management *Plus*:

The vacuum pump continuous to run for approx. 5 min. when process control is stopped to remove remaining condensate if necessary, symbol pump is flashing.

Example basic setup **Management *Plus***: PC 510 connected to a rotary evaporator

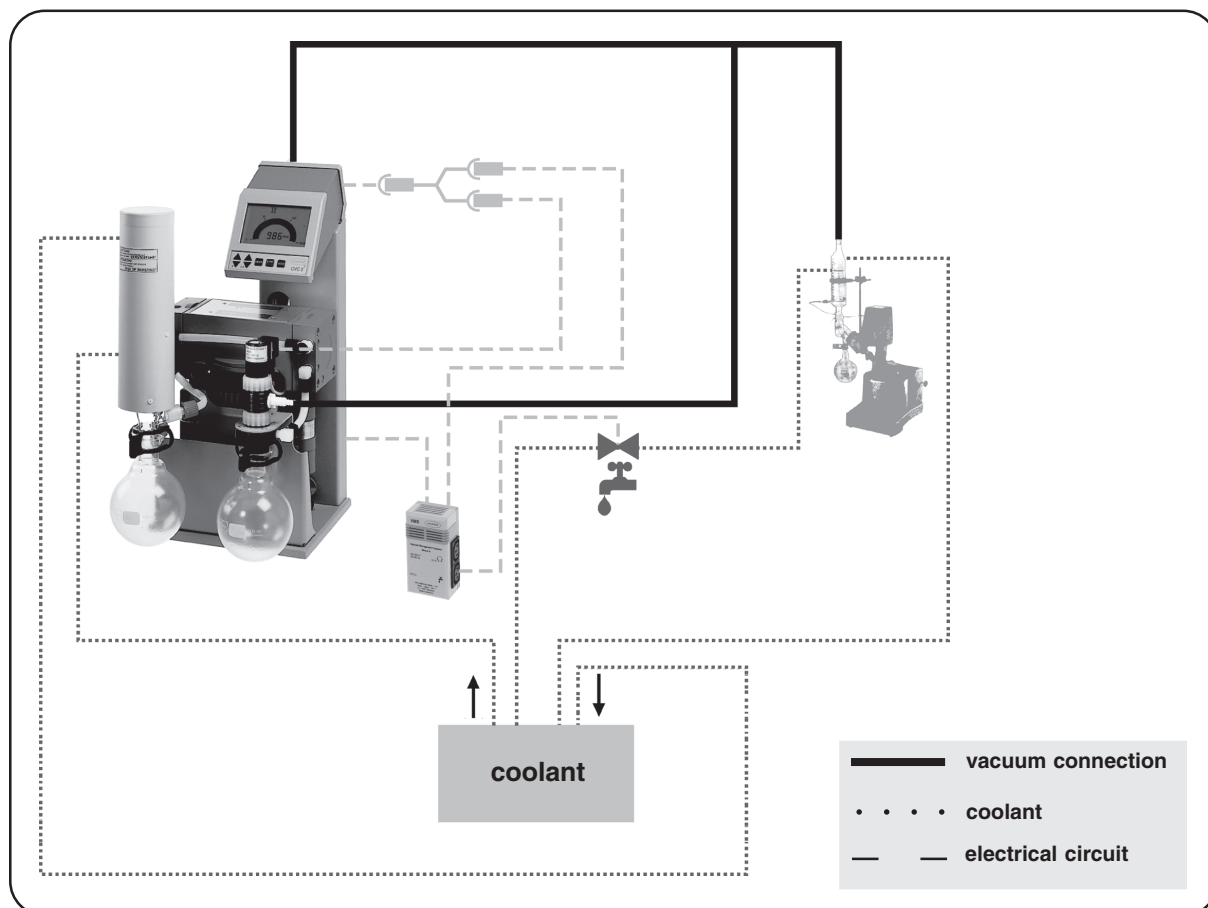

Example basic setup **Management: MZ 2C + AK + EK, VACUU•LAN® components with isolation valves**

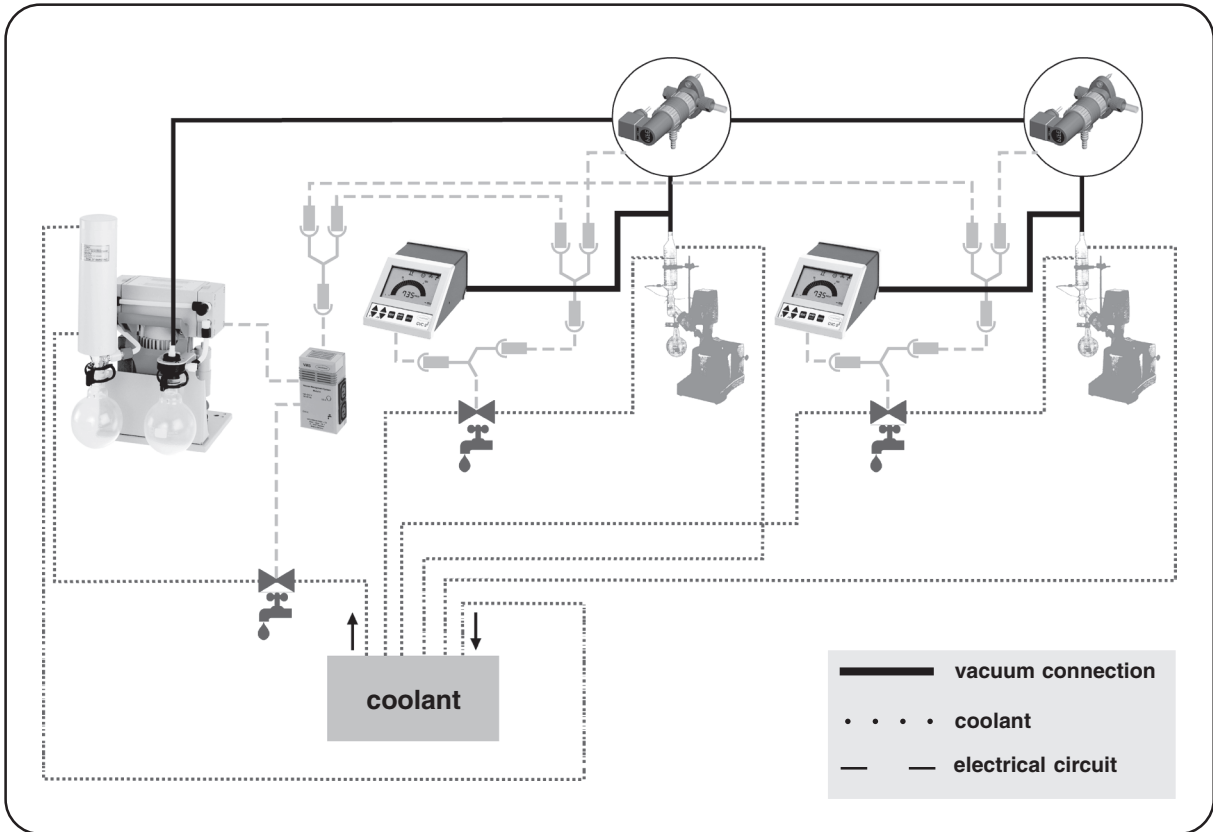

Example basic setup **Management: MZ 2C + AK + EK, without isolation valve**

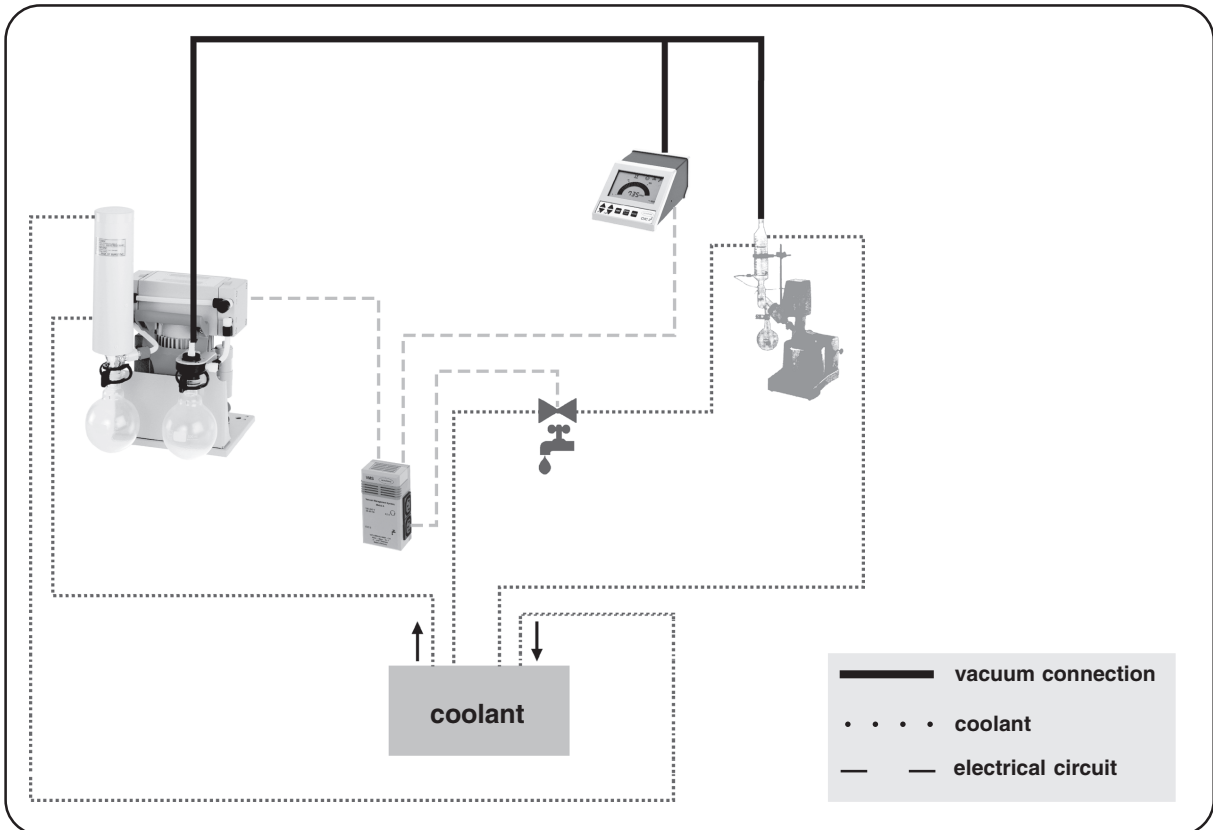

## General view basic setup **VACUU•LAN**

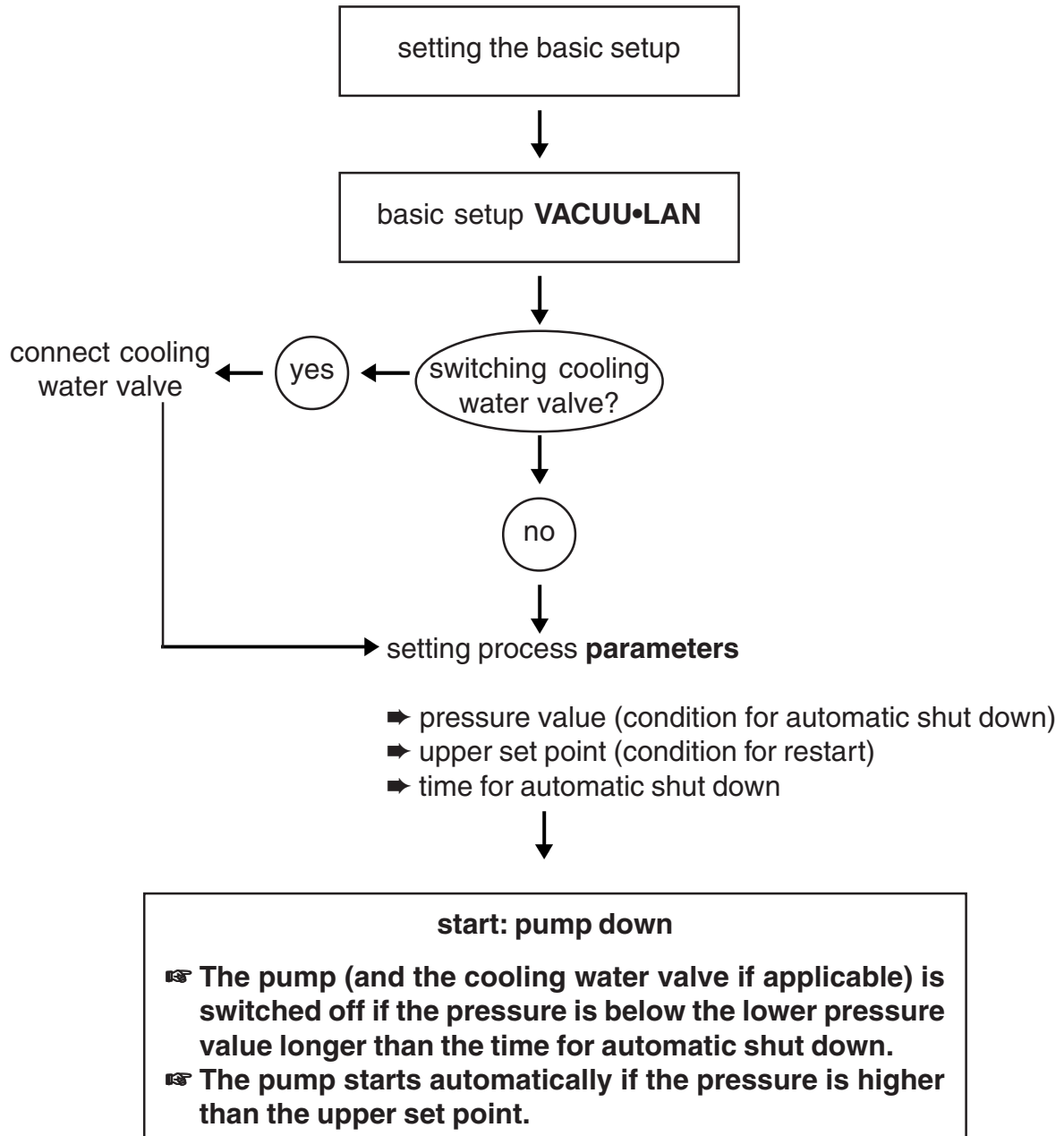

# Basic setup VACUU•LAN

## After switching on

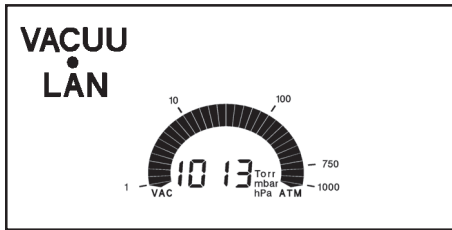

The process control is inactive, i. e. the controller is ready for vacuum control, but control operation has not been activated.

**In basic setup VACUU•LAN it is not possible to activate the two-point control.**

The controller is in operation mode continuous pumping.

- ☞ The actual pressure is displayed.
- ☞ Values as from last operation are reactivated (factory-set: time for automatic switch off 15 minutes, pressure value 20 mbar, upper set point 200 mbar).
- ☞ Press key START/STOP to start process control.

## Starting and stopping process control

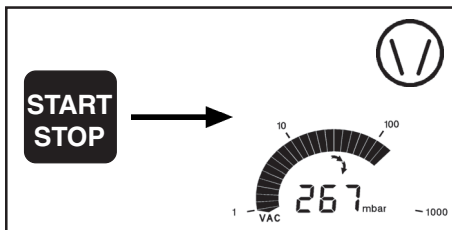

- ➔ **To start** the process control: Press key START/STOP.
  - ☞ The pump is switched on.
  - ☞ If the cooling water valve is preselected: Cooling water valve opens immediately, the symbol is displayed.
  - ☞ The pump (and the cooling water valve if applicable) is switched off if the pressure is below the lower pressure value longer than the time for automatic shut down.
  - ☞ The pump starts automatically if the pressure is higher than the upper set point.
- ➔ **To stop** process control: After time for automatic shut down or pressing key START/STOP the process control is stopped.
  - ☞ The pump is switched off.
  - ☞ If a cooling water valve is preselected: Cooling water valve is switched off.

## Venting

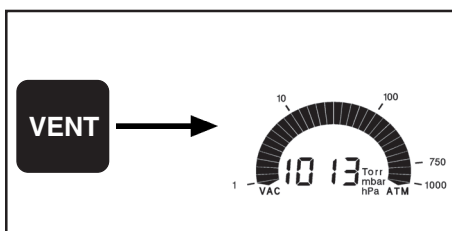

**Short venting** (e. g. in case of retardation of boiling or if sudden foaming occurs):

- ➔ Press key VENT shortly (< 2 sec.).
- ☞ Pumping is interrupted, the process control is stopped.

**Venting the system:**

- ➔ Press key VENT continuously (> 2 sec.) until symbol air admittance valve is displayed.
- ☞ Pumping is interrupted, the process control is stopped.
- ☞ Ventilation until pressure does not change any more, i. e. until atmospheric pressure is attained
- ☞ Key STOP interrupts venting at any time.



**Attention: If pressurized inert gas is used install an overpressure relief valve. Max. pressure at the pressure transducer 1600 mbar! Ensure that high pressure is compatible with the mechanical stability of the system!**

## Setting the process parameter

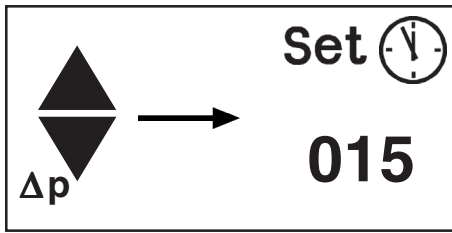

### Setting the **time for automatic shut down**:

- ➔ Press key  $\Delta p \blacktriangle$  or  $\Delta p \blacktriangledown$ .
- ☞ "Set" and the clock symbol and the time for automatic shut down are displayed for approx. 1 s (factory-set 15 min).
- ☞ With a second tip within one second or continuous pressing:
- ➔ Press key  $\Delta p \blacktriangle$  or  $\Delta p \blacktriangledown$  to set value for time for shut down (0 to 200 minutes).
- ☞ The value for the shut down time is stored as the new set point when the key is released.

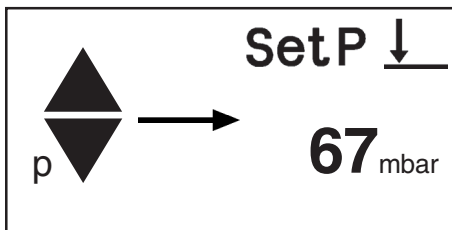

### Setting the **lower pressure value** (condition for automatic shut down; factory-set: 20 min.):

- ➔ Press  $p \blacktriangle$  or  $p \blacktriangledown$ .
- ☞ "Set p", "arrow down" and the lower pressure value are displayed for approx. one second.
- ☞ With a second tip within one second or continuous pressing:
- ➔ Set the lower set point by pressing key  $p \blacktriangle$  or  $p \blacktriangledown$ .
- ☞ The lower pressure value is stored as the new set point when the key is released.

*Note: Choose the pressure value in a range which is achieved in the vacuum system if there is no more gas or vapour generation at the vacuum connections.*

*It is recommended to select a pressure value which is approx. 10 mbar higher than the ultimate pressure value achievable in the system (normally the ultimate vacuum of the pump).*

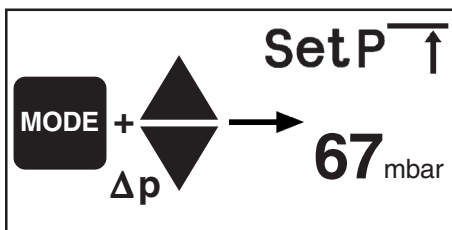

### Setting the **upper pressure value** (condition for restart; factory-set 200 mbar):

- ➔ While key MODE is pressed, press key  $\Delta p \blacktriangle$  or  $\Delta p \blacktriangledown$ .
- ☞ "Set p", "arrow up" and the upper pressure value are displayed for approx. one second.

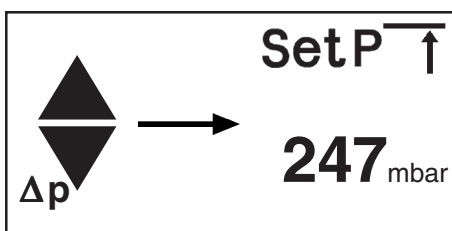

- ☞ With a second tip within one second or continuous pressing:
- ➔ Set the upper pressure value by pressing key  $\Delta p \blacktriangle$  or  $\Delta p \blacktriangledown$ .
- ☞ The upper pressure value is stored as the new set point when the key is released.

*Note: If the value of the upper pressure value is set below the value of the lower pressure value, the upper pressure value is inactivated. The pump starts immediately.*



Example basic setup **VACUU•LAN**: PC 510, VACUU•LAN® components with isolation valve, ball valve or flow control diaphragm

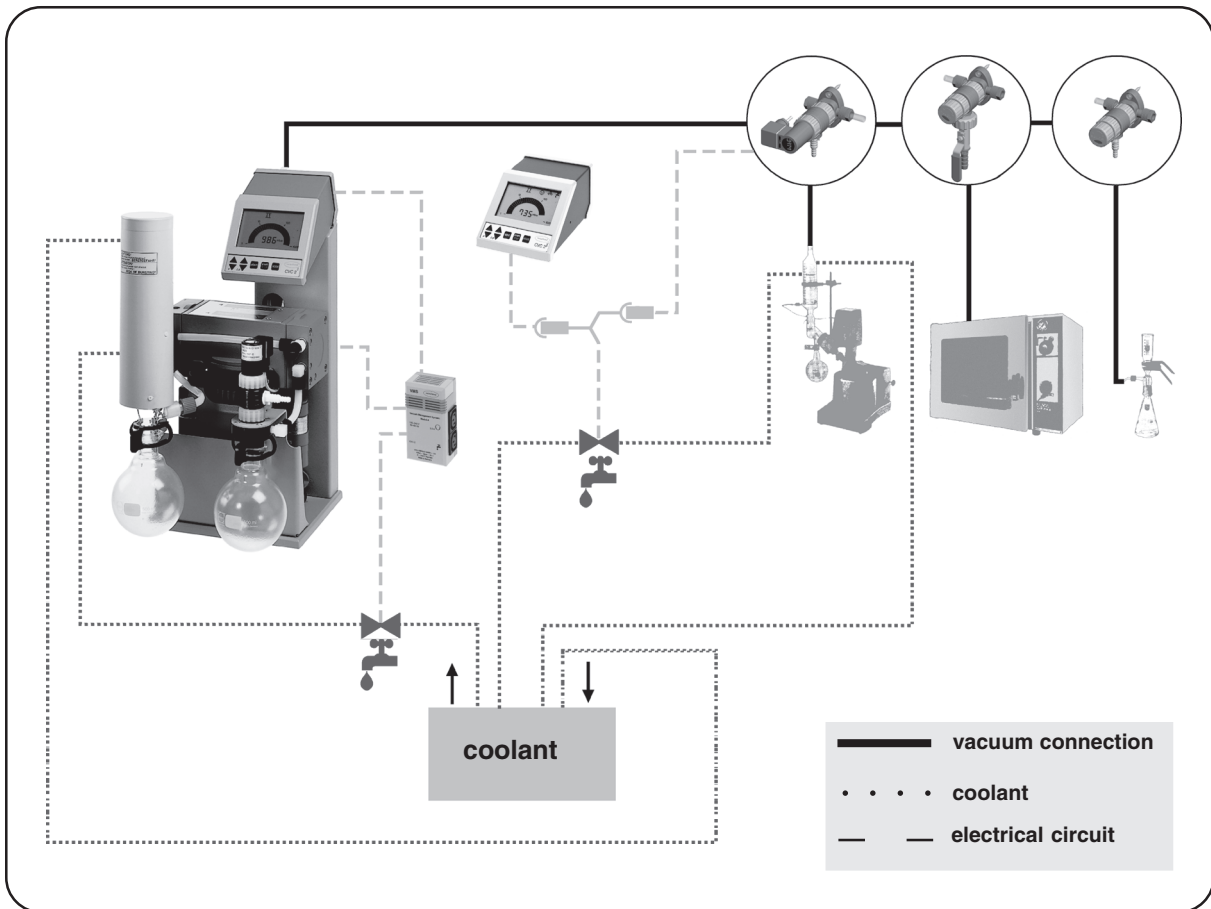

## How to determine the best distillation conditions

### Measure the temperature of the available coolant.

- ☞ In most cases the coolant temperature is given (e. g. tap water, in house cooling water circuit). For maximum solvent recovery, carefully choose the boiling point of the product (by choosing the vacuum level) and the bath temperature accordingly.
- ☞ Determine the lowest boiling point of the product (solvent).
- ☞ The temperature difference between boiling point of the product and the coolant should be more than 20°C, Otherwise low vacuum level will lead to significant loss of solvent.
- ☞ Select a water bath temperature of 20-30°C above the boiling point of the product to provide sufficient heat transfer.
- ☞ If there is no limitation from the product side, a water bath temperature of 60-70°C is usually recommended (efficient heating with minimum generation of water vapour from the bath).

### Example: Vacuum selection for a boiling temperature of 40°C:

- ☞ The cooling temperature assumed to be 15-20°C.
- ☞ Water bath temperature between 60-70°C. Wait until temperature is reached.
- ☞ Determine the vacuum level for a boiling point (use published data of solvents). Reduce pressure until a sufficient level of evaporation is attained.
- ☞ If hysteresis is set manually, avoid frequent operation of the isolation valve (approx. not more than two operations per minute).

### List of solvents

Solvent	Boiling point (°C) at 1013 mbar	Vacuum for boiling point (mbar) (abs.) at $T_s=40^\circ\text{C}$	Solvent	Boiling point (°C) at 1013 mbar	Vacuum for boiling point (mbar) (abs.) at $T_s=40^\circ\text{C}$
Acetone	56	556	Ethyl acetate	77	240
Acetonitrile	82	230	Ethylene-dichloride	83	210
Benzene	80	236	Hexane	69	335
t-Butanol	82	130	Methanol	64	337
1-Butanol	118	25	Pentane	36	> 1000
Chloroform	62	474	Isopropanol	82	137
Cyclohexane	81	235	Pyridine	115	60
Dichloromethane	40	1000	Tetrachloromethane	77	271
Diethyl ether	35	> 1000	Tetrahydrofurane	66	357
Diisopropyl ether	68	375	Toluene	111	77
Dimethyl-formamide	153	11	Trichloroethylene	87	183
1,4-Dioxane	101	107	Xylene	138	25
Ethanol	78	175	Water	100	72

### Appropriate selection of $\Delta p$

- Choose  $\Delta p$  in a range from 5 mbar (high boiling solvents, e. g. water, toluene) to 150 mbar (low boiling solvents, e. g. methanol, dichloromethane).

p mbar	5	10	50	80	100	200	500	700	900	1000
$\Delta p$ mbar	2	3	5	10	15	35	70	90	120	150

**Note:** Changing set point p while process control is stopped leads at the same time to automatic preselection of  $\Delta p$ . During process control hysteresis is adapted only in case of great set point changes. Hysteresis  $\Delta p$  can be changed manually at any time.

## Installation and accessories



In combination with VACUUBRAND chemistry diaphragm pumps and additional accessories, the controller can be upgraded to a system which

- recovers solvents next to 100%.
- allows to operate simultaneously several work stations with one chemistry vacuum pump by using the components of the VACUU•LAN®.
- controls pump and cooling water process-orientated.
- allows to adapt the system quickly and cost-efficient to specific requirements thanks to its modular concept.

### Components

the VACUUBRAND chemistry vacuum system consists e. g. of the following components:

#### Vacuum generation



**Chemistry diaphragm pump MD 4C** (230 V, 50/60 Hz)  
3,0 m<sup>3</sup>/h, 2 mbar ..... **69 62 92**

**Chemistry diaphragm MZ 2C** (230 V, 50/60 Hz)  
1,7 m<sup>3</sup>/h, 9 mbar ..... **69 62 41**

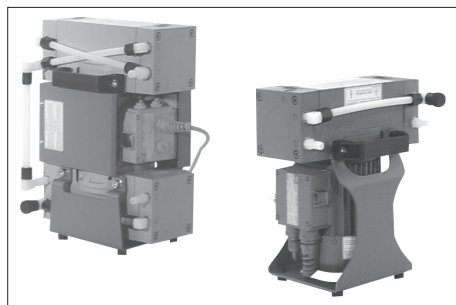

**Pump support kit**  
(for installation of the diaphragm pump in vertical position)

- space saving
- avoiding accumulation of condensate in the pump

**Pump support MD 4C** ..... **69 99 24**

**Pump support MZ 2C** ..... **69 99 25**

#### Solvent recovery



The **exhaust waste vapour condenser** enables an easy and efficient condensation of vapours under atmospheric pressure.

- catchpot at the inlet prevents condensates from entering the pump
- exhaust waste vapour condenser for condensation at cooling water temperature and atmospheric pressure at favourable thermodynamic conditions
- next to 100% solvent recovery

**Upgrade AK + EK for MZ 2C** ..... **69 99 26**  
(baseplate with catchpot at the inlet and exhaust waste vapour condenser)

## Vacuum distribution

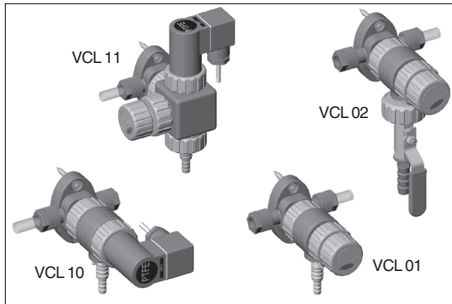

The VACUU•LAN® modules allow process orientated, flexible and cost effective connections according to the requirements: One vacuum pump for multiple work stations.

<b>VACUU•LAN® manual flow control module</b>	
<b>VCL 01</b> .....	<b>67 71 06</b>
<b>VACUU•LAN® shut off / manual flow control module VCL 02</b> .....	<b>67 71 07</b>
<b>VACUU•LAN® automatic control module</b>	
<b>VCL 10</b> .....	<b>67 71 08</b>
<b>VACUU•LAN® manual flow control/automatic control module VCL 11</b> .....	<b>67 71 09</b>

On this page we offer only a small selection of VACUU•LAN® options. Please refer for further information.

## Cooling water minimization



<b>Cooling water valve 24 V=</b> .....	<b>67 60 13</b>
- compact design, designed for a high number of operations at short intervals	
- solenoid systems with splash protection	
- conductance optimised for applications with rotary evaporator and exhaust waste vapour condenser	
- with integrated Y-connector to connect an isolation valve	

<b>Cooling water valve 230 V~, 50-60 Hz</b> .....	<b>67 60 10</b>
(for use with the VMS)	

<b>Y-socket-plug connector</b> .....	<b>67 60 15</b>
(to connect several components to the bush of the CVC 2 <sup>nd</sup> , e. g. for simultaneous operation of isolation valve and VMS)	

## Accessories of controller



<b>Solenoid operated isolation valve</b>	
<b>VV 6C 24 V=</b> .....	<b>67 40 91</b>
(PVDF/PTFE, small flange NW 16, hose nozzle NW 6/10)	
<b>Solenoid operated isolation valve</b>	
<b>VV 6 24 V=</b> .....	<b>67 40 90</b>
(PP/FPM, small flange NW 16, hose nozzle NW 6/10)	
<b>Solenoid operated isolation valve</b>	
<b>VV 15C 24 V=</b> .....	<b>67 41 10</b>
(PVDF/PTFE, small flange NW 16)	
<b>Solenoid operated isolation valve</b>	
<b>VV 15 24 V=</b> .....	<b>67 41 15</b>
(PVDF/PTFE, small flange NW 25)	

## Troubleshooting

Fault	Possible cause	Remedy
<input type="checkbox"/> No display.	<ul style="list-style-type: none"> <li>➔ Mains not plugged in?</li> <li>➔ Other causes (device defective)?</li> </ul>	<ul style="list-style-type: none"> <li>☞ Insert mains plug, check mains fuses in the building.</li> <li>☞ Return the device to the factory for repair.</li> </ul>
<input type="checkbox"/> Display disappears, internal overload protection becomes actuated.	<ul style="list-style-type: none"> <li>➔ Thermal overload, is ambient temperature too high?</li> <li>➔ Short circuit in the connected components?</li> <li>➔ Other causes (device defective)?</li> </ul>	<ul style="list-style-type: none"> <li>☞ Make sure ventilation is adequate.</li> <li>☞ Isolate components, replace if necessary.</li> <li>☞ Return the device to the factory for repair.</li> </ul>
<input type="checkbox"/> Isolation valve is open all the time - valve symbol is displayed.	<ul style="list-style-type: none"> <li>➔ Too high evaporation rate?</li> <li>➔ Too high leak rate?</li> <li>➔ Too low set point as regards the pump?</li> </ul>	<ul style="list-style-type: none"> <li>☞ Reduce evaporation rate.</li> <li>☞ Switch off, check for leak tightness.</li> <li>☞ Raise the set point or change to a pump, which can attain the required vacuum or has a higher pumping speed (check diameter and length of pipeline between pump and system).</li> </ul>
<input type="checkbox"/> Valve symbol is displayed, isolation valve remains closed.	<ul style="list-style-type: none"> <li>➔ Mechanical or electrical damage of the isolation valve?</li> </ul>	<ul style="list-style-type: none"> <li>☞ Clean or repair isolation valve.</li> </ul>
<input type="checkbox"/> Pressure reading is incorrect.	<ul style="list-style-type: none"> <li>➔ Adjustment has drifted off?</li> <li>➔ Moisture in the pressure transducer?</li> <li>➔ Short circuit in the connected valves?</li> </ul>	<ul style="list-style-type: none"> <li>☞ Readjust the device.</li> <li>☞ Dry, e. g. by pumping the transducer, readjust, use gas washing bottle if necessary.</li> <li>☞ Replace valves.</li> </ul>
<input type="checkbox"/> Digital pressure display and warning triangle are flashing.	<ul style="list-style-type: none"> <li>➔ Overpressure at the pressure transducer, pressure &gt; 1300 mbar?</li> </ul>	<ul style="list-style-type: none"> <li>☞ Relieve pressure immediately (transducer may suffer damage).</li> </ul>
<input type="checkbox"/> Warning triangle is flashing in basic setup Standard or Management <i>Plus</i> .	<ul style="list-style-type: none"> <li>➔ Isolation valve is missing.</li> </ul>	<ul style="list-style-type: none"> <li>☞ Connect isolation valve or choose another basic setup.</li> </ul>
<input type="checkbox"/> Warning triangle is flashing in basic setup Management.	<ul style="list-style-type: none"> <li>➔ Pump is switched more than 3 times during 30 seconds.</li> </ul>	<ul style="list-style-type: none"> <li>☞ Choose adequate parameters (increase <math>\Delta p</math>).</li> </ul>

Fault	Possible cause	Remedy
<input type="checkbox"/> Increasing pressure after closing the isolation valve.	<ul style="list-style-type: none"> <li>➔ Too high leak rate in the vacuum system?</li> <li>➔ Lower set point too low for process?</li> <li>➔ Integrated air admittance valve defective?</li> </ul>	<ul style="list-style-type: none"> <li>☞ Switch off, check for leak tightness.</li> <li>☞ Check process parameter, raise the set point if necessary.</li> <li>☞ Return the device to the factory for repair.</li> </ul>
<input type="checkbox"/> Pump does not work.	<ul style="list-style-type: none"> <li>➔ Valve and pump connected to VMS, operation mode Standard?</li> <li>➔ VMS connected, pump symbol is not displayed?</li> <li>➔ VMS connected, pump symbol is displayed, thermal overload of the pump?</li> </ul>	<ul style="list-style-type: none"> <li>☞ Choose another operation mode or connect pump directly to mains supply.</li> <li>☞ No fault in basic setup Management <i>Plus</i> or VACUU-LAN.</li> <li>☞ Allow the pump to cool down, check system.</li> </ul>
<input type="checkbox"/> Pump and cooling water valve at the VMS are driven, but do not operate.	<ul style="list-style-type: none"> <li>➔ Fuse at the VMS defective?</li> </ul>	<ul style="list-style-type: none"> <li>☞ Check system, replace fuse if necessary.</li> </ul>
<input type="checkbox"/> Controller does not react when operating keys. No change after switching off/on.		<ul style="list-style-type: none"> <li>☞ Return the device to the factory for repair.</li> </ul>



Instructions for repair with directions for repair and spare parts list are available on request.

☞ The instructions are for trained service people.

## Readjustment



The device was adjusted using factory standards, which are traceable through regular calibration in an accredited laboratory (German Calibration service) to the national standard. Depending on the process and/or accuracy requirements, check the adjustment and readjust if necessary. For readjustment, the device has to be adjusted both at **atmospheric pressure** as well as under **vacuum**.

The adjustment mode can be activated only if the process control is inactive. Press key STOP if necessary.

### Adjustment at atmospheric pressure

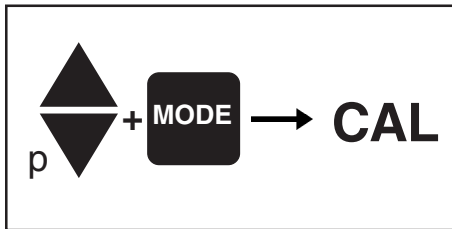

Ventilate the controller and/or the vacuum system. Make sure that the vacuum connection at the controller is at atmospheric pressure.

- ➔ Press key p▲ or p▼ simultaneous with key MODE, the controller then switches to the adjustment mode.
- ☞ "CAL" is displayed for approx. 2 seconds.
- ➔ While "CAL" is displayed, press key START/STOP.
- ➔ Use key p▲ or p▼ to adjust the reading to actual atmospheric pressure.
- ➔ Press key STOP to confirm.

**Note:** To determine the actual atmospheric pressure, use an accurate barometer or get accurate reading from the weather service, the next airport.....(take into account the difference in altitude between e. g. airport and laboratory).

### Adjustment under vacuum

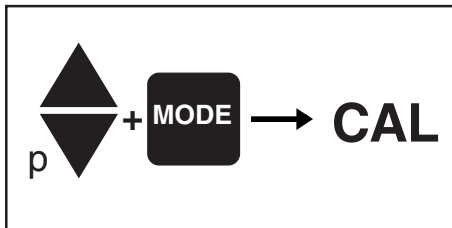

Evacuate the controller to a pressure < 0.5 mbar (e. g. by applying a good rotary vane pump).

- ➔ Press key p▲ or p▼ simultaneous with key MODE, the controller then switches to the adjustment mode.
- ☞ "CAL" is displayed for approx. 2 seconds.
- ➔ While "CAL" is displayed, press key START/STOP.
- ☞ The reading is automatically adjusted to "zero".
- ➔ Press key STOP to confirm.

**Note:** Adjustment under vacuum with an actual pressure higher than 0.5 mbar reduces the accuracy of the measurement. If the pressure is significantly higher than 0.5 mbar, adjustment to a reference pressure is recommended.

### Adjustment at a reference pressure

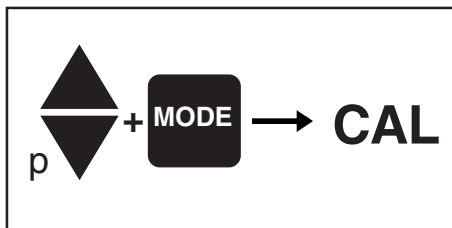

Instead of adjustment under vacuum to a pressure < 0.5 mbar, adjustment to a reference pressure within the range of 0 ..... 20 mbar is possible.

- ➔ Press key p▲ or p▼ simultaneous with key MODE, the controller then switches to the adjustment mode.
- ☞ "CAL" is displayed for approx. 2 seconds.
- ➔ While "CAL" is displayed, press key START/STOP.
- ☞ The reading is automatically adjusted to "zero".
- ➔ Use keys p▲ or p▼ to adjust the display to the reference pressure at the vacuum line within the range of 0 ..... 20 mbar.
- ➔ Press key STOP to confirm.

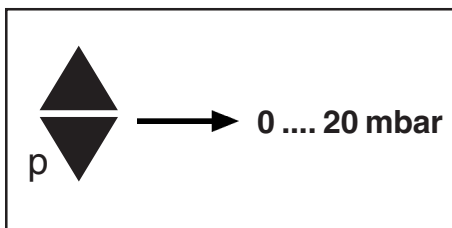

**Note:** The accuracy of the value of the reference pressure will directly affect the accuracy of the adjustment. If the nominal ultimate vacuum of a diaphragm pump is used as reference vacuum, the accuracy of the controller might be doubtful. The diaphragm pump may not achieve the specified value (due to condensate, poor state, failure of valves or the diaphragm).

# Calibration in the factory

## Control of measuring equipment

The **VACUUBRAND DKD calibration laboratory** is accredited by the Physikalisch-Technische Bundesanstalt (PTB; German national institute for science and technology and the highest technical authority of the Federal Republic of Germany for the field of meteorology and certain sectors of safety engineering) for the measurable variable **pressure in the pressure range from  $10^{-3}$  mbar to 1000 mbar** in accordance with the general criteria for the operation of testing laboratories defined in the DIN EN ISO/IEC 17025:2000 series of standards.

Calibration in the VACUUBRAND calibration laboratory:

- To meet the requirements of the DIN ISO 9000ff and 10012 series of standards regarding the calibration of inspection, measuring and test equipment at specified intervals.
- To document that the vacuum gauges calibrated are traceable to national standards of the PTB.



## Notes on return to the factory

### Repair - return - DKD calibration



Safety and health of our staff, laws and regulations regarding the handling of dangerous goods, occupational health and safety regulations and regulations regarding safe disposal of waste require that for all pumps and other products the “**Health and safety clearance form**”

must be send to our office duly completed and signed before any equipment is dispatched to our premises.

Fax or post a completed copy of the health and safety clearance form to us in advance. The declaration must arrive before the equipment. Enclose a second completed copy with the product. If the equipment is contaminated you must notify the carrier.

**No repair / DKD calibration is possible unless the correctly completed form is returned. Inevitably, there will be a delay in processing the equipment if information is missing or if this procedure is not obeyed.**

If the product has come in contact with chemicals, radioactive substances or other substances dangerous to health or environment, the product must be decontaminated prior to **sending it back to the factory.**

- ☞ Return the product to us **disassembled and cleaned** and accompanied by a certificate verifying decontamination or
- ☞ Contact an industrial cleaning and **decontamination service** directly or
- ☞ Authorize us to send the product to an industrial cleaning facility **at your expense.**



To expedite repair and to reduce costs, please enclose a detailed description of the problem and the product’s operating conditions with every product returned for repair. We submit **quotations** only on request and always at the customer’s expense. If an order is given, the costs incurred are offset from the costs for repair or from the purchase price, if the customer prefers to buy a new product instead of repairing the defective one.

☞ **If you do not wish a repair on the basis of our quotation, the equipment might be returned to you disassembled and at your charge!**

In many cases, the **components must be cleaned in the factory** prior to repair.

For cleaning we use an environmentally responsible water based process. Unfortunately the combined attack of elevated temperature, cleaning agent, ultrasonic treatment and mechanical stress (from pressurised water) may result in damage to the paint. Please mark in the health and safety clearance form if you wish a **repaint at your expense** just in case such a damage should occur.

We also replace parts due to optical aspects upon your request.

**Before returning** the equipment ensure that (if applicable):

- ☞ Oil has been drained and an adequate quantity of fresh oil has been filled in to protect against corrosion.
- ☞ Equipment has been cleaned and/or decontaminated.
- ☞ All inlet and outlet ports have been sealed.
- ☞ Equipment has been properly packed, if necessary, please order an original packaging (costs will be charged), marked as appropriate and the carrier has been notified.
- ☞ Ensure that the completed health and safety declaration is enclosed.



We hope for your understanding for these measures, which are beyond our control.

#### **Scrapping and waste disposal:**

Dispose of the equipment and any components removed from it safely in accordance with all local and national safety and environmental requirements. Particular care must be taken with components and waste oil which have been contaminated with dangerous substances from the process. Do not incinerate fluoroelastomer seals and O-rings.

- ☞ You may authorize us to dispose of the equipment **at your expense.**







**Konformitätserklärung  
Declaration of conformity  
Déclaration de conformité**

**Vakuum-Controller / Vacuum controller / Régulateur de vide**

**CVC 2<sup>II</sup> (230V; 683150, 683151, 683152)**

Hiermit erklären wir, dass das oben bezeichnete Gerät in Konzeption und Bauart sowie in der von uns in Verkehr gebrachten Ausführung den grundlegenden Anforderungen der zutreffenden, aufgeführten EU-Richtlinien entspricht. Bei einer mit uns nicht abgestimmten Änderung an dem Gerät verliert diese Erklärung ihre Gültigkeit.

We herewith declare that the product designated above is in compliance with the basic requirements of the applicable EC-directives stated below with regard to design, type and model sold by us. This certificate ceases to be valid if the product is modified without the agreement of the manufacturer.

Par la présente, nous déclarons que le dispositif désigné ci-dessus est conforme aux prescriptions de base des directives EU applicables et indiqués en ci que concerne conception, dessin et modèle vendu par nous-mêmes. Cette déclaration cesse d'être valable si des modifications sont apportées au dispositif sans notre autorisation préalable.

Niederspannungsrichtlinie / Low-Voltage Directive / Directive Basse Tension  
2006/95/EG

Richtlinie Elektromagnetische Verträglichkeit / Electromagnetic Compatibility Directive / Directive  
Compatibilité Electromagnétique  
2004/108/EG

Angewandte Harmonisierte Normen / Harmonized Standards applied / Normes Harmonisées utilisées  
DIN EN 61010-1, DIN EN 61326-1

Managementsysteme / Management systems / Systèmes de Management  
EN ISO 9001, EN ISO 14001 (1997-2006)

Wertheim, 15.12.2009

Ort, Datum / place, date / lieu, date

(Dr. F. Gitmans)

Geschäftsführer / Managing Director / Gérant

ppa.

(Dr. J. Dirscherl)

Technischer Leiter / Technical Director / Directeur technique

**VACUUBRAND GMBH + CO KG**

-Vakuumtechnik im System-  
-Technology for Vacuum Systems-  
-Technologie pour système à vide-

Alfred-Zippe-Str. 4 - 97877 Wertheim

Tel.: +49 9342 808-0 - Fax: +49 9342 808-450

E-Mail: [info@vacuubrand.de](mailto:info@vacuubrand.de)

Web: [www.vacuubrand.com](http://www.vacuubrand.com)

Disclaimer: Our technical literature is only intended to inform our customer. The validity of general empirical values and results obtained under test conditions for specific applications depend on a number of factors beyond our control. It is therefore strictly the users' responsibility to very carefully check the validity of application to their specific requirements. No claims arising from the information provided in this literature will, consequently, be entertained.

**VACUUBRAND GMBH + CO KG**  
-Technology for Vacuum Systems-

© 2009 VACUUBRAND GMBH + CO KG Printed in Germany

Alfred-Zippe-Str. 4 - 97877 Wertheim  
Tel.: +49 9342 808-0 - Fax: +49 9342 808-450  
E-Mail: [info@vacuubrand.de](mailto:info@vacuubrand.de)  
Web: [www.vacuubrand.com](http://www.vacuubrand.com)

