



Technology for Vacuum Systems

Instructions for use

Part I of II



Part I:
Safety information -
Technical data -
Use and operation

PC 3001 VARIO^{pro}
PC 3001 TE VARIO^{pro}
PC 3001 VARIO^{pro} IK
PC 3001 VARIO^{pro} EK Peltronic

Chemistry pumping unit with speed control

Dear customer,

Your VACUUBRAND diaphragm pumps are designed to provide you with many years of trouble-free service with optimal performance. Our many years of practical experience allow us to provide a wealth of application and safety information. Please read these instructions for use before the initial operation of your pump.

VACUUBRAND diaphragm pumps combine our many years of experience in design, construction and practical operation, with the latest developments in material and manufacturing technology.

Our quality maxim is the "zero defect" principle:

Every diaphragm pump, before leaving our factory, is tested intensively, including an endurance run of 18 hours. Any faults, even those which occur rarely, are identified and can be eliminated immediately.

After completion of the endurance run, every pump is tested, and must achieve specifications before shipment.

We are committed to providing our customers only pumps that meet this high quality standard.

While our pumps cannot eliminate all of your work, we design, manufacture and test them to ensure that they will be an effective and trouble-free tool to assist you in that work.

Yours,

VACUUBRAND GMBH + CO KG

After sales service:

Contact your local dealer or call +49 9342 808-5500.

Trademark index:

VACUU•LAN® (US-Reg.No 3,704,401), VACUU•BUS®, VACUU•CONTROL™, chemistry-HYBRID™, Peltronic®, TURBO•MODE™, VARIO® (US-Reg.No 3,833,788), VARIO-SP™, VACUUBRAND® (US-Reg.No 3,733,388) and also the shown company logos are trademarks of VACUUBRAND GMBH + CO KG in Germany and/or other countries.

DE

Achtung: Die vorliegende Betriebsanleitung ist nicht in allen EU-Sprachen verfügbar. Der Anwender darf die beschriebenen Geräte nur dann in Betrieb nehmen, wenn er die vorliegende Anleitung versteht oder eine fachlich korrekte Übersetzung der vollständigen Anleitung vorliegen hat. Die Betriebsanleitung muss vor Inbetriebnahme der Geräte vollständig gelesen und verstanden werden, und alle geforderten Maßnahmen müssen eingehalten werden.  "Sicherheitshinweise für Vakuumgeräte"

EN

Attention: This manual is not available in all languages of the EU. The user must not operate the device if he does not understand this manual. In this case a technically correct translation of the complete manual has to be available. The manual must be completely read and understood before operation of the device and all required measures must be applied.  "Safety instructions for vacuum equipment"

FR

Attention: Le mode d'emploi présent n'est pas disponible dans toutes les langues d'Union Européenne. L'utilisateur ne doit mettre le dispositif en marche que s'il comprend le mode d'emploi présent ou si une traduction complète et correcte du mode d'emploi est sous ses yeux. Le dispositif ne doit pas être mis en marche avant que le mode d'emploi ait été lu et compris complètement et seulement si le mode d'emploi est observé et tous les mesures demandées sont prises.

 «Avis de sécurité pour des dispositifs à vide»

BG

Внимание: Тези инструкции не са преведени на всички езици от ЕО. Потребителят не бива да работи с уреда, ако не разбира инструкциите за ползване. В този случай е необходимо да бъде предоставен пълен технически превод на инструкциите за ползване. Преди работа с уреда е задължително потребителят да прочете изцяло инструкциите за работа.

 "Указания за безопасност за вакуумни уреди"

CN

注意：该操作手册不提供所有的语言版本。操作者在没有理解手册之前，不能操作该设备。在这种情况下，需要有一个整个操作手册技术上正确的翻译。在操作该设备前，必须完全阅读并理解该操作手册，必须实施所有需要的测量。

 真空设备的安全信息

CZ

Upozornění :Tento návod k použití není k dispozici ve všech jazycích Evropské unie. Uživatel není oprávněn požit přístroj pokud nerozumí tomuto návodu. V takovém případě je nutno zajistit technicky korektní překlad manuálu do češtiny. Návod musí být uživatelem prostudován a uživatel mu musí plně porozumět před tím než začne přístroj používat. Uživatel musí dodržet všechna příslušná a požadovaná opatření.  "Bezpečnostní upozornění pro vakuové přístroje".

DA

Bemærk: Denne manual foreligger ikke på alle EU sprog. Brugeren må ikke betjene apparatet hvis manualen ikke er forstået. I det tilfælde skal en teknisk korrekt oversættelse af hele manual stilles til rådighed. Manual skal være gennemlæst og forstået før apparatet betjenes og alle nødvendige forholdsregler skal tages.

 »Sikkerhedsregler for vakuumdstyr«

EE

Tähelepanu! Käesolev kasutusjuhend ei ole kõigis EL keeltes saadaval. Kasutaja ei tohi seadet käsitseda, kui ta ei saa kasutusjuhendist aru. Sel juhul peab saadaval olema kogu kasutusjuhendi tehniliselt korrektne tõlge. Enne seadme kasutamist tuleb kogu juhend läbi lugeda, see peab olema arusaadav ning kõik nõutud meetmed peavad olema rakendatud.  "Ohutusnõuded vaakumseadmetele"

ES

Atención: Este manual no está disponible en todos los idiomas de UE. El usuario no debe manejar el instrumento si no entiende este manual. En este caso se debe disponer de una traducción técnicamente correcta del manual completo. El manual debe ser leído y entendido completamente y deben aplicarse todas las medidas de seguridad antes de manejar el instrumento.  "Notas sobre la seguridad para equipos de vacío"

FI

Huomio: Tämä käyttöohje ei ole saatavilla kaikilla EU: n kielillä. Käyttäjä ei saa käyttää laitetta, jos hän ei ymmärrä tätä ohjekirjaa. Tässä tapauksessa on saatavilla oltava teknisesti oikein tehty ja täydellinen ohjekirjan käännös. Ennen laitteen käyttöä on ohjekirja luettava ja ymmärrettävä kokonaan sekä suoritettava kaikki tarvittavat valmistelut ja muut toimenpiteet.  "Vakuumlaitteen turvallisuustiedot"

GR

Προσοχή! : Οι οδηγίες αυτές δεν είναι διαθέσιμες σε όλες τις γλώσσες της Ευρωπαϊκής Ένωσης. Ο χρήστης δεν πρέπει να θέσει σε λειτουργία την συσκευή αν δεν κατανοήσει πλήρως τις οδηγίες αυτές. Σε τέτοια περίπτωση ο χρήστης πρέπει να προμηθευτεί ακριβή μετάφραση του βιβλίου οδηγιών. Ο χρήστης πρέπει να διαβάσει και να κατανοήσει πλήρως τις οδηγίες χρήσης και να λάβει όλα τα απαραίτητα μέτρα πριν θέσει σε λειτουργία την συσκευή.  "Υποδείξεις ασφάλειας για αντλίες κενού"

HR

Pažnja: ove upute ne postoje na svim jezicima Europske Unije. Korisnik nemora raditi sa aparatom ako ne razumije ove upute. U tom slučaju tehnicki ispravni prijevod cijelih uputstava mora biti na raspolaganju. Uputstva moraju biti cijela procitana i razumljiva prije rada sa aparatom i sve zahtijevane mjere moraju biti primjenjene.

 "Sigurnosne napomene za vakuumske uređaje"

HU

Figyelem! Ez a kezelési utasítás nem áll rendelkezésre az EU összes nyelvén. Ha a felhasználó nem érti jelen használati utasítás szövegét, nem üzemeltetheti a készüléket. Ez esetben a teljes gépkönyv fordításáról gondoskodni kell. Üzembe helyezés előtt a kezelőnek végig kell olvasnia, meg kell értenie azt, továbbá az üzemeltetéshez szükséges összes mérést el kell végeznie.  "A vákuum-készülékekkel kapcsolatos biztonsági tudnivalók"

IT

Attenzione: Questo manuale non è disponibile in tutte le lingue della Comunità Europea (CE). L'utilizzatore non deve operare con lo strumento se non comprende questo manuale. In questo caso deve essere resa disponibile una traduzione tecnicamente corretta del manuale completo. Il manuale deve essere completamente letto e compreso prima di operare con lo strumento e devono essere applicati tutti gli accorgimenti richiesti.  "Istruzioni di sicurezza per apparecchi a vuoto"

JP

注意：この取扱説明書はすべての言語で利用可能ではありません。もしこの取扱説明書を理解できないならば、ユーザーは装置を操作してはなりません。この場合、技術的に正しい翻訳がなされた完全なマニュアルを用意しなければなりません。装置を作動する前にマニュアルを完全に読み、そして理解されなくてはなりません。そして、すべての要求される対策を講じなければなりません。

 真空装置を安全に取り扱うために

KR

주의: 이 매뉴얼은 모든 언어로 번역되지 않습니다. 만약 이 매뉴얼의 내용을 충분히 인지하지 못했다면 기기를 작동하지 마십시오. 매뉴얼의 내용을 기술적으로 정확하게 번역한 경우에 이용하십시오. 기기를 사용하기 전에 이 매뉴얼을 충분히 읽고 이해하고 모든 요구되는 사항들을 적용해야 합니다.

 진공 장비에 대한 안전 정보

LT

Dėmesio: šis vadovas nėra pateikiamas visomis ES kalbomis. Naudotojui draudžiama eksploatuoti įtaisą, jeigu jis nesupranta šio vadovo. Tokiu atveju reikia turėti viso vadovo techniškai taisyklingą vertimą. Vadovą būtina visą perskaityti ir suprasti pateikiamas instrukcijas prieš pradėdant eksploatuoti įtaisą, bei imtis visų reikiamų priemonių.  "Vakuuminės įrangos saugos informacija"

LV

Uzmanību: Lietotāja instrukcija nav pieejama visās ES valodās. Lietotājs nedrīkst lietot iekārtu, ja viņš nesaprot lietotāja instrukcijā rakstīto. Šādā gadījumā, ir nepieciešams nodrošināt tehniski pareizu visas lietotāja instrukcijas tulkojumu. Pirms sākt lietot iekārtu, un, lai izpildītu visas nepieciešamās prasības, iekārtas lietotāja instrukcija ir pilnībā jāizlasa un jāsaprot.  "Vakuuma iekārtu drošības noteikumi"

NL

Attentie: Deze gebruiksaanwijzing is niet in alle talen van de EU verkrijgbaar. De gebruiker moet niet met dit apparaat gaan werken als voor hem/haar de gebruiksaanwijzing niet voldoende duidelijk is. Bij gebruik van deze apparatuur is het noodzakelijk een technisch correcte vertaling van de complete gebruiksaanwijzing te hebben. Voor het in gebruik nemen van het apparaat moet de gebruiksaanwijzing volledig gelezen en duidelijk zijn en dienen alle benodigde maatregelen te zijn genomen.  "Veiligheidsvoorschriften voor vacuümapparaten"

PL

Uwaga!! Ta instrukcja nie jest dostępna we wszystkich językach Unii Europejskiej. Użytkownik nie może rozpocząć pracy z urządzeniem dopóki nie przeczytał instrukcji i nie jest pewien wszystkich informacji w niej zawartych. Instrukcja musi być w całości przeczytana i zrozumiana przed podjęciem pracy z urządzeniem oraz należy podjąć wszystkie niezbędne kroki związane z prawidłowym użytkowaniem.

 "Wskazówki bezpieczeństwa do urządzeń próżniowych"

PT

Atenção: Este manual não está disponível em todas as línguas da UE. O usuário não deve utilizar o dispositivo, se não entender este manual. Neste caso, uma tradução tecnicamente correta do manual completo tem de estar disponível. O manual deve ser lido e entendido completamente antes da utilização do equipamento e todas as medidas necessárias devem ser aplicadas.  "Informação de Segurança para Equipamento que funciona a Vácuo"

RO

Atentie: Acest manual nu este disponibil in toate limbile EU. Utilizatorul nu trebuie sa lucreze cu aparatul daca nu intelege manualul. Astfel, va fi disponibile o traducere corecta si completa a manualului. Manualul trebuie citit si inteles in intregime inainte de a lucra cu aparatul si a luat toate masurile care se impun.

 "Instrucțiuni de siguranță pentru aparatele de vidare"

RU

Внимание: Эта инструкция по эксплуатации не имеется на всех языках. Потребителю не дозволено эксплуатировать данный прибор, если он не понимает эту инструкцию. В этом случае нужен технически правильный перевод полной инструкции. Прежде чем использовать этот прибор, необходимо полностью прочитать и понять эту инструкцию и принять все необходимые меры.  "Указания по технике безопасности при работе с вакуумными устройствами"

SE

Varning: Denna instruktion är inte tillgänglig på alla språk inom EU. Användaren får inte starta utrustningen om hon/han inte förstår denna instruktion. Om så är fallet måste en tekniskt korrekt instruktion göras tillgänglig. Instruktionen måste läsas och förstås helt före utrustningen tas i drift och nödvändiga åtgärder göres.

 "Säkerhetsinformation för vakuumutrustning"

SI

Pozor: Ta navodila niso na voljo v vseh jezikih EU. Uporabnik ne sme upravljati z napravo, če ne razume teh navodil. V primeru nerazumljivosti mora biti na voljo tehnično pravilen prevod. Navodila se morajo prebrati in razumeti pred uporaba naprave, opravljene pa moraja biti tudi vse potrebne meritve.

 "Varnostni nasveti za vakuumske naprave"

SK

Upozornenie: Tento manuál nie je k dispozícii vo všetkých jazykoch EÚ. Užívateľ nesmie obsluhovať zariadenie, pokiaľ nerozumie tomuto manuálu. V takomto prípade musí byť k dispozícii technicky správny preklad celého manuálu. Pred obsluhou zariadenia je potrebné si prečítať celý manuál a porozumieť mu, a musia byť prijaté všetky opatrenia.  "Bezpečnostné pokyny pre vákuové zariadenia"

TR

Dikkat : Bu kullanım kitabı, tüm dillerde mevcut değildir. Kullanıcı, bu kullanım kitabını anlayamadıysa cihazı çalıştırmamalıdır. Bu durumda, komple kullanım kitabının, teknik olarak düzgün çevirisinin bulunması gerekir. Cihazın çalıştırılmasından önce kullanım kitabının komple okunması ve anlaşılması ve tüm gerekli ölçümlerin uygulanması gerekir.  "Vakumlu cihazlar için güvenlik uyarıları"

Reset / Language selection

1 switch off



2 press both ↓ ↓

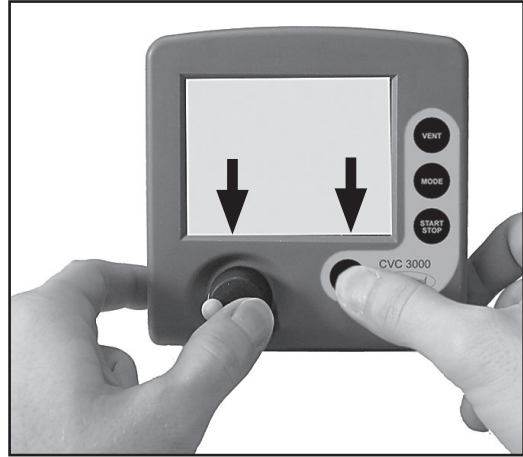

3 turn ↺ ↻



4 press ↓



Contents

Part I	1
Reset / Language selection	8
Safety information!	11
Important information!	11
General information.....	13
Intended use.....	13
Setting up and installing the equipment	14
Ambient conditions	16
Operating conditions	17
Safety during operation	19
Maintenance and repair.....	23
⚠ Important information: Equipment marking (ATEX)	25
Technical data	27
General technical data valid for all pumping units.....	27
Gas inlet temperatures	30
Wetted parts	30
Abbreviations.....	31
Pump parts	31
Use and operation	38
Installing a pump in a vacuum system	38
Notes regarding the (dry) ice condenser	43
Notes concerning the operation of the inlet condenser IK	45
Notes concerning the operation of the Peltronic emission condenser	46
Notes concerning the operation of pumping units with silencer	46
During operation.....	46
Important notes regarding the use of gas ballast	48
Important notes concerning the operation of the exhaust waste vapor condenser.....	49
Shutdown & storage.....	51
CVC 3000 Vacuum controller	52
Menu guide	57
Pump down function	59
Vac Control function	61
Auto mode	64
Program function	66
Application example	68

VACUULAN function	69
Application examples	71
Vacuum for filtration and suction	71
Vacuum for gel dryer, drying chambers and vacuum concentrators	72
Vacuum for distillation and evaporation (e.g., rotary evaporator)	72
Vacuum for VACUU•LAN networks	74
Configuration	75
Part II	77
Readjustment of CVC 3000	80
Calibration in the factory	82
Cleaning the pressure transducer	83
Interface parameters	84
Setting of the interface	85
Read commands "CVC 2000"	86
Write commands "CVC 2000"	87
Read commands "CVC 3000"	89
Write commands "CVC 3000"	91
Accessories	94
Troubleshooting	95
Replacing diaphragms and valves	99
Cleaning and inspecting the pump heads	101
Disassembling the housing cover at the side of the emission condenser.....	103
Replacing the diaphragm	105
Assembling the housing cover at the side of the emission condenser.....	108
Disassembling the housing cover at the side of the ON/OFF switch	108
Assembling the housing cover at the side of the ON/OFF switch	109
Assembling the fittings.....	109
Cleaning and replacing components	112
Notes on return to the factory	113
Warranty	116
Health and safety clearance form	117
EC Declaration of Conformity of the Machinery	118

Safety information!

Important information!

WARNING

- ☞ **Keep this manual complete and accessible to personnel at all times!**
- ☞ **Read this manual carefully before installing or operating the equipment. Observe the instructions contained in this manual.**
PC 3001 VARIO^{pro} with Peltronic emission condenser: Read the manual of the emission condenser Peltronic as well and observe likewise the instructions contained in that manual.
- ☞ **Do not modify the equipment without authorization.**

NOTICE

This manual is an integral part of the equipment described therein. It describes the safe and proper use of the vacuum pump. The manual consists of two parts. Make operating personnel aware of dangers arising from the pump and the pumped substances. VACUUBRAND disclaims any liability for inappropriate use of these pumps and for damage from failure to follow instructions contained in this manual.

This manual is only to be used and distributed in its complete and original form. It is strictly the users' responsibility to check carefully the validity of this manual with respect to his product.

Manual-no.: 999166 / 03/14/2012

The following signal word panels and safety symbols are used throughout this manual:



This is the safety alert symbol. It is used to alert you to potential personal injury hazards. Obey all safety messages that follow this symbol to avoid possible injury and death.



➔ DANGER indicates a hazardous situation which, if not avoided, will result in death or serious injury.



☞ WARNING indicates a hazardous situation which, if not avoided, could result in death or serious injury.



• CAUTION indicates a hazardous situation which, if not avoided, could result in minor or moderate injury.



NOTICE is used to address practices not related to personal injury.



Caution! Hot surface!



Disconnect equipment from AC power.



Dispose of electronic equipment according to regulations.



This product has been tested to the requirements of CAN/CSA-C22.2 No. 61010-1, second edition, including amendment 1, or a later version of the same standard incorporating the same level of testing requirements.

Formatting used in this manual:

Note: The signal word panels in all sections of this manual always refer to all paragraphs of the same format (➔ / ☞ / • / plain text) following each signal word panel.

The document "Safety information for vacuum equipment" is part of this manual! Read the "Safety information for vacuum equipment" and observe the instructions contained therein!

General information

NOTICE

Remove all packing material from the packing box. Remove the product from its packing-box and retain all packaging until the equipment is inspected and tested. Remove the protective caps from the inlet and outlet ports and retain for future use. Inspect the equipment promptly and carefully.

If the equipment is damaged, notify the supplier and the carrier in writing within three days. Retain all packing material for inspection. State the item number of the product together with the order number and the supplier's invoice number. Failure to check and give notice of damage will void any and all warranty claims for those deficiencies.

Replace the protective caps if the equipment is not used immediately. Store the equipment in dry and non-corrosive conditions (see also „Technical data“, pg. 27).

WARNING

☞ **Do not use any damaged equipment.**

CAUTION

- Use the mounted handle when moving the pumping unit.

Intended use

WARNING

- ☞ Do not use the pump or any system parts on humans or animals.
- ☞ Prevent any part of the human body from coming into contact with vacuum.
- ☞ Ensure that the individual components are only connected, combined and operated according to their design and as indicated in the instructions for use.
- ☞ Comply with all notes on correct vacuum and electrical connections; see section „Use and operation“, pg. 38.
- ☞ Do not use the pump to generate pressure.
- ☞ The pumps are designed for **ambient temperatures** during operation between +50°F and +104°F (+10°C and +40°C). Periodically check maximum temperatures

if installing the pump in a cabinet or a housing. Make sure ventilation is adequate to maintain recommended operating temperature. Install an external automatic ventilation system if necessary. If pumping hot process gases, make sure that the maximum permitted gas inlet temperature is not exceeded. The maximum permitted gas inlet temperature depends on several parameters like inlet pressure and ambient temperature (see „Technical data“, pg. 27).

- ☞ Do not aspirate particles and dust.
- ☞ Do not pump liquids.

CAUTION

- Ensure that the pump, and any accessories in the flow path are chemically resistant to the pumped substances prior to operation.

NOTICE

Use the equipment **only as intended**, that is, for generation, measurement, and control of vacuum in vessels designed for that purpose. Any other use will automatically invalidate all warranty and liability claims. Remain aware of safety and risks.

Setting up and installing the equipment

DANGER

- ➔ Equipment must be connected only to a **suitable electrical supply** and a suitable ground point. As such, the plug must be plugged into an outlet that is properly grounded. Failure to connect the motor to ground may result in deadly electrical shock.

The supply cable may be fitted with a molded European IEC plug or a plug suitable for your local electrical supply. The cable contains wires color coded as follows: green or green and yellow: ground; blue or white: neutral; brown or black: hot.

WARNING

- ☞ Due to the high compression ratio, the pump may generate overpressure at the outlet. Check pressure compatibility with system components (e.g., exhaust pipe-

line or exhaust valve) at the outlet.

- ☞ Do not permit any **uncontrolled pressurizing**. Make sure that the exhaust pipeline cannot become blocked. If there is an exhaust isolation valve, make sure that you cannot operate the equipment with the valve closed to avoid a **risk of bursting!**
- ☞ Maximum permissible pressure at the pressure transducer: 21.8 psi (1.5 bar) absolute.
- ☞ Always provide a free and pressureless exhaust outlet to avoid damage to pump valves and risk of bursting of condenser glassware.
- ☞ Check the overpressure safety relief device at the exhaust waste vapor condenser at appropriate intervals.

- ☞ Keep the electrical power cord away from heated surfaces.

CAUTION

- Provide a firm, level platform for the equipment. Check that the system which you are going to evacuate is mechanically stable. Check that all fittings are secure. Ensure a stable position of the pump without any mechanical contact other than the pump feet.

- Comply with **maximum permissible pressures** at inlet and outlet and with **maximum permissible pressure differences** between inlet and outlet. See section „Technical data“, pg. 27. Do not operate the pump with overpressure at the inlet.
- Avoid overpressure of more than 17.5 psi absolute (1.2 bar absolute) in the event that inert gas is connected to the pump, to the gas ballast or to a venting valve.

- **Note:** Flexible elements will shrink when evacuated.
- Connect hoses gas tight at inlet and outlet of the pump.

- Ensure that no foreign objects can be drawn into the pump.
- Check the power source and the pump's rating plate to be sure that the power source and the equipment match in voltage, phase, and frequency.

- Ensure that the **coolant outlet pipe** is always free and that it cannot get blocked. If installing an optional coolant valve, it must always be in the supply line of the exhaust waste vapor condenser.

NOTICE

Keep a minimum distance of 8 in (20 cm) between the cooling fan and surrounding items (e.g., housing, walls, etc.). Clean ventilation slots if necessary to avoid a reduction of ventilation.

Do not place the pumping unit on soft surfaces (e.g., rubber foam) during operation. This may reduce or block the electronics' air supply. Do not cover the pumping unit.

Use only hoses at the inlet and outlet of the pump with an inner diameter at least as large as the diameter of the pump's tubing (to avoid overpressure at the outlet, and reduction of pumping speed at the inlet).

Allow the equipment to equilibrate to ambient temperature if you bring it from cold environment into a room prior to operation. Notice if there is water condensation on cold surfaces.

Secure coolant hoses at the hose nozzles (e.g., with hose clamp) to prevent their accidental slipping.

Comply with all **applicable and relevant safety requirements** (regulations and guidelines). **Implement the required actions and adopt suitable safety measures.**

Ambient conditions**DANGER**

- ➔ Do not reach for this product if it has fallen into liquid. There is a risk of deadly electrical shock. Unplug the system immediately.

WARNING

- ☞ Do not use this product in an area where it can fall or be pulled into water or other liquids.

- ☞ Pay attention to the **maximum permissible ambient and gas inlet temperatures** (see „Technical data“, pg. 27).

CAUTION

- Adopt suitable measures in case of differences from recommended conditions, e.g., using the equipment outdoors, installation in altitudes of more than 6500 ft (2000 m) above mean sea level, conductive pollution or external condensation on the pump.
- Do not operate this product near flames.

NOTICE

To the best of our knowledge the equipment is in compliance with the requirements of the applicable EC-directives and harmonized standards (see "Declaration of Conformity") with regard to design, type and model. Directive EN 61010-1 gives in detail the conditions under which the equipment can be operated safely (see also IP degree of protection, „Technical data“, pg. 27).

Operating conditions

DANGER

- ➔ These pumps are not approved for operation in potentially explosive atmospheres. **Do not operate the pumps in potentially explosive atmospheres.**
- ➔ Pumps **without the "⊕x" mark on the rating plate are not approved for the pumping of potentially explosive atmospheres. Do not pump potentially explosive atmospheres** with those pumps.
- ➔ Pumps **bearing the "⊕x" mark on their rating plates are approved for the pumping of potentially explosive atmospheres** according to their classification **II 3G IIC T3 X** according to ATEX, but they are **not approved for operation in potentially explosive atmospheres** (see section „⊕x Important information: Equipment marking (ATEX)“, pg. 25).
- ➔ The pumps are **not suitable** to pump any of the substances listed below.

Do not pump:

- **unstable substances**
- substances which react explosively under **impact** (mechanical stress) without air
- substances which react explosively when being exposed to **elevated temperatures** without air,
- substances subject to **auto-ignition**,
- substances which are **inflammable without air**
- **explosive substances.**

➔ The pumps are **not approved** for operation below ground. **Do not operate** the pump **below ground.**



☞ The pumps are **not suitable** for pumping dust. **Do not pump dust.**



- **Do not pump** substances which may form **deposits** inside the pump. The pumps are not suitable for pumping substances which may form deposits inside the pump. Deposits and condensate in the pump may lead to increased temperatures even to the point of exceeding the maximum permitted temperatures.
- Check the inlet and outlet of the pump, if there is a danger of forming **deposits** inside the pump, e.g., in the pump chambers (the pump chamber is the part between diaphragm and head cover. See section „Replacing diaphragms and valves“, pg. 99). Inspect the pump chambers regularly and clean if necessary.
- **Consider interactions and chemical reactions of the pumped media.** Ensure that the materials of the pump's wetted parts are compatible with the pumped substances, see section „Technical data“, pg. 27. When changing the substances pumped, we recommend purging the pump with air or inert gas prior to changing the pumped media. Purging the pump will pump out residues and it will reduce the possibility of reactions of the pumped substances with each other and with the pump's materials.

Safety during operation

! DANGER

- ➔ Adopt suitable measures to prevent the release of dangerous, toxic, explosive, corrosive, noxious or polluting fluids, vapors and gases. To prevent any emission of such substances from the pump outlet, install an appropriate collecting and disposal system and take protective action for pump and environment.
- ➔ You must take suitable precautions to prevent any formation of explosive mixtures in the pump chamber or at the outlet of the pump. In case, e.g., of a diaphragm failure, mechanically generated sparks, hot surfaces or static electricity may ignite these mixtures. Use inert gas for gas ballast or venting, if necessary.
- ➔ Drain appropriately or otherwise remove any potentially explosive mixtures at the outlet of the pump, or dilute them with inert gas to non-explosive concentrations.
- ➔ Never operate this pump if it has a damaged cord or plug.

! WARNING

- ☞ If the pump is not working properly, has been dropped or has fallen into water, contact your pump service provider.
- ☞ Prevent any part of the human body from coming into contact with vacuum.
- ☞ Never aspirate liquids or dust into the pump.
- ☞ Make sure that the exhaust pipeline cannot become blocked.
- ☞ Check the overpressure safety relief device at the exhaust waste vapor condenser at appropriate intervals.
- ☞ Avoid clogging of the exhaust vapor condenser caused by deposits or freezing solvents.
- ☞ **Attention:** At pressures above approximately 795 Torr (1060 mbar) the pressure reading becomes incorrect due to saturation of the pressure transducer. The dis-

play flashes. Release pressure immediately! Risk of bursting!

- ☞ Comply with applicable regulations when disposing of chemicals. Take into consideration that chemicals may be contaminated. Take adequate precautions to protect people from the effects of dangerous substances (chemicals, thermal decomposition products of fluoroelastomers). Use appropriate protective clothing and safety goggles.

- ☞ Use only **original manufacturer's spare parts and accessories**. Otherwise the safety and performance of the equipment, as well as the electromagnetic compatibility of the equipment might be reduced.
The CE mark or the cTÜVus mark may be voided if not using original manufacturer's spare parts.

- ☞ Interruption of the pump (e.g., due to power failure), failure of connected components or of parts of the supply, or change in parameters must not be allowed to lead to dangerous conditions. In case of a diaphragm failure or in case of a leak in the manifold, pumped substances might be released into the environment or into the pump housing or motor.
Comply with all notes regarding proper use of the pumps, as well as operation and maintenance guidance.

- ☞ The residual **leak rate of the equipment** might render possible an exchange of gas, albeit extremely slight, between the environment and the vacuum system.
Adopt suitable measures to prevent contamination of the pumped substances or the environment.

PC 3001 TE VARIO^{pro}:

- ☞ Cold surfaces can absorb a great amount of gas, which may expand abruptly in case of warming. This may lead to unmanageable overpressure in the system, creating a risk of bursting!
- ☞ Check the coolant level of the condenser at appropriate

intervals.

- ☞ **Attention:** Coolant may overflow unexpectedly, e.g., in case of large amounts of gas.
- ☞ Do not overfill the condenser. Lowest permissible coolant temperature: -112°F (-80°C).
- ☞ Maximum operating pressure: 16 psi (1.1 bar) absolute.

CAUTION

- Ensure that no parts of your clothing, hair or fingers can be caught or drawn in at the inlet of the pump. Never insert fingers or drop any other object into the inlet or outlet.
- Pumping at high inlet pressure may lead to overpressure at the gas ballast valve. Pumped gases or condensate might be expelled if the valve is open. If an inert gas supply is connected to the gas ballast, ensure that its inlet pipeline is not contaminated.
- You must take suitable precautions to prevent any dangerous situation from arising if the controller starts the pump, switches a coolant valve or opens a venting valve.
- **Attention:** If the controller is set to **Autostart**, the process will start immediately after a power failure without pressing any further key. It is your responsibility to ensure that automatic start-up of the system will not lead to any dangerous condition. Provide appropriate safety measures. Check **prior to starting the process** whether the option "*Autostart*" (menu: configuration) is enabled.
- Pay attention to the safety symbol "hot surfaces" on the equipment. Hot parts may cause burns if touched. Adopt suitable measures to prevent any danger arising from hot surfaces or electric sparks. Ensure that hot surfaces of the pump do not cause burns. Provide a suitable contact guard if necessary.
- Ensure that the **coolant outlet pipe** at the waste vapor condenser is always free and that it cannot get blocked.



PC 3001 TE VARIO^{pro}:

- Comply with all applicable safety measures and requirements when using cryogenic coolants (e.g., dry ice).
Attention: Coolant media may cause severe frostbite when coming in contact with skin!
- Prior to every use: Inspect the condenser for faults. There must be no damage on the glass surface. Do not use damaged components.
- Use only transport receptacles intended for coolants.
- Wear safety glasses and protective gloves.
- Do not clamp the covers of condensers or coolant receptacles. Allow pressure equalization between coolant and atmosphere.

NOTICE

Do not start the pump if the pressure difference between inlet and outlet exceeds 16 psi (1.1 bar) at maximum. Prevent the backpressure of gases and the backflow of condensates at the outlet.

Check the liquid level in the catchpots or in the collecting flask regularly and drain condensate in time to prevent overflowing. Install a level sensor (see „Accessories“, pg. 94) for monitoring, if necessary.

Provide appropriate protective measures to allow for the possibility of failure and **malfunction**. The protective measures must also allow for the requirements of the respective application.

The CVC 3000 controller is powered by a short-circuit-proof wide-range power supply with integrated overload protection.

A temperature sensor at the circuit board protects the motor: Current limitation in case the temperature at the circuit board raises above 158°F (70°C). At temperatures above 185°F (85°C) the pump is switched off. In case of a motor blockage (after 10 start-up attempts) the pump is switched off.

Note: Only manual reset is possible. Disconnect the pump

from the power source. Identify and eliminate the cause of failure.

Maintenance and repair

NOTICE

In order to comply with laws (occupational, health and safety regulations, safety at work law and regulations for environmental protection) vacuum pumps, components and measuring instruments can only be returned when certain procedures (see section „Notes on return to the factory“, pg. 113) are followed.

Take advantage of our service seminars, which put special focus on the maintenance and repair of vacuum pumps. For details and for the online "Instructions for repair" manual see www.vacuubrand.com.

In case of normal wear, the lifetime of the diaphragms and valves is > 10000 operating hours. Bearings have a typical durability of 40000 h.

DANGER

➔ **Ensure that the pump cannot be operated accidentally. Never operate the pump if covers or other parts of the pump are disassembled.**



➔ **Switch off the pump. Disconnect the electrical power cord and wait two minutes** before starting maintenance to allow the capacitors to discharge.

➔ **Note:** The pump may be contaminated with process chemicals, which have been pumped during operation. Ensure that the pump is completely decontaminated before maintenance commences.

WARNING

➔ Take adequate precautions to protect people from the effects of dangerous substances if contamination has occurred. Use appropriate protective clothing, safety goggles and protective gloves.

- ☞ **Wear parts have to be replaced regularly.**
- ☞ **Never operate a defective or damaged pump.**

- ☞ Vent the pump before starting maintenance. Isolate the pump and other components from the vacuum system. Allow sufficient cooling of the pump. Separate the pump from the coolant circuit and drain condensate, if applicable.

NOTICE

Ensure that **maintenance** is done only by suitably trained and supervised technicians. Ensure that the maintenance technician is familiar with the safety procedures which relate to the products processed by the pumping system. Only dismantle the pump as far as necessary.



 Important information: Equipment marking (ATEX)**VACUUBRAND equipment bearing mark (see rating plate)**

 II 3G IIC T3 X
Internal Atm. only
Tech. File Ref.: VAC-EX01

and

VACUUBRAND equipment bearing mark (see rating plate)

 X see manual

For equipment labelled with „ X see manual“ the following classification according to Directive 94/9/EC (ATEX) is valid:  II 3G IIC T3 X, Internal Atm. only, Tech. File Ref.: VAC-EX01.

The classification II 3G IIC T3 X according to ATEX is only valid for the inner part (wetted part, pumped gas or vapor) of the equipment. The equipment is not suitable for use in external, potentially explosive atmospheres (environment).

The overall category of the equipment depends on the connected components. If the connected components do not comply with the classification of the VACUUBRAND equipment, the specified category of the VACUUBRAND equipment is no longer valid.

Vacuum pumps and vacuum gauges in category 3 are intended for connection to equipment in which during normal operation explosive atmospheres caused by gases, vapors or mists normally don't occur; or, if they do occur, are likely to do so only infrequently and for a short period only. Equipment in this category ensures the requisite level of protection during normal operation.

The use of gas ballast or the operation of venting valves is only permitted if thereby explosive atmospheres normally don't occur in the interior of the equipment or, if they do occur, are likely to do so only infrequently and for a short period.

The pumps are marked with "X" (according to EN 13463-1), i.e., restrictions of the operation conditions:

- The equipment is designated for a low degree of mechanical stress and has to be installed in a way so that it cannot be damaged from outside.
Pumping units have to be installed so that they are protected against shocks from the outside and against glass splinters in the event of breakage (implosion).
- The equipment is designated for an ambient and gas inlet temperature during operation of +10 to +40°C. Never exceed these ambient and gas inlet temperatures. If pumping / measuring gases which are not potentially explosive, extended gas inlet temperatures are permissible. See instructions for use, section "Gas inlet temperatures" or "Technical data".

After any intervention at the equipment (e.g., repair / maintenance) the ultimate vacuum of the pump has to be checked. Only if the pump achieves its specified ultimate vacuum is the pump's leak rate low enough to ensure that no explosive atmospheres will occur in the interior of the equipment.

After any intervention at the vacuum sensor, the leak rate of the equipment has to be checked.



Attention: This manual is not available in all languages of the EU. The user must not operate the device if he does not understand this manual. In such a case, a technically correct translation of the complete manual has to be available. The manual must be completely read and understood before operation of the device and all required measures must be applied.

Technical data

General technical data valid for all pumping units		
Maximum pumping speed (ISO 21360)	cfm (m ³ /h)	1.2 (2.0)
Ultimate vacuum (absolute) without gas ballast*	Torr (mbar)	1.5 (2)
Ultimate vacuum (absolute) with gas ballast*	Torr (mbar)	3 (4)
Maximum permissible inlet and outlet pressure (absolute)	psi (bar)	16 (1.1)
Maximum permissible pressure difference between inlet and outlet	psi (bar)	16 (1.1)
Maximum permissible pressure (abso- lute) at gas ballast valve	psi (bar)	17.5 (1.2)
Permissible ambient temperature storage / operation	°F (°C)	14 to 140 / 50 to 104 (-10 to +60 / +10 to +40)
Permissible relative atmospheric mois- ture during operation (no condensation)	%	30 to 85
Rated motor power	hp (kW)	0.21 (0.16)
No-load speed**	rpm	0 - 3000
Maximum permissible range of supply voltage (±10%) Attention: Observe specifications of rating plate!		100-120 V~ 50-60 Hz 200-230 V~ 50-60 Hz
Maximum rated current at: 100-120 V~ 50-60 Hz 200-230 V~ 50-60 Hz	A A	1.6 0.7
Device fuse Fuse of VACUU•BUS 24V DC supply		F7A fuse on the circuit board T0.5A slow blow fuse (with automatic reset) on the circuit board
Motor protection		current limitation (temperature sensor on the circuit board)
Degree of protection IEC 529		IP 20
Volume of catchpot	quarts (ml)	0.52 (500)
A-weighted emission sound pressure level*** (uncertainty K _{pA} : 3 dB(A))	dB(A)	42

Type		PC 3001 VARIO ^{pro}	PC 3001 VARIO ^{pro} IK
Inlet		hose nozzle for tubing I.D. 1/4" / 3/8" (hose nozzle DN 6/10 mm)	hose nozzle for tubing I.D. 1/2" (hose nozzle DN 13 mm)
Outlet		hose nozzle for tubing I.D. 3/8" (hose nozzle DN 10 mm) ^{****}	
Coolant connection (waste vapor condenser)		hose nozzle for tubing I.D. 1/4" - 5/16" (hose nozzle DN 6-8 mm)	
Maximum permissible pressure of coolant at vapor condenser	psi (bar)	87 (absolute) (6 (absolute))	
Permissible range of coolant temperature (vapor condenser)	°F (°C)	5 to 68 (-15 to +20)	
Dimensions L x W x H approx.	in (mm)	11.8 x 12.0 x 15.7 (300 x 306 x 400)	12.2 x 12.3 x 15.7 (309 x 312 x 400)
Weight approx.	lbs. (kg)	17.0 (7.7) ^{*****}	18.3 (8.3)

* Ultimate vacuum at setting "Pump down" at speed "HI"

** Running smoothly only at motor speeds higher than 200 rpm

*** Measurement according to EN ISO 2151:2004 and EN ISO 3744:1995 at 1500rpm and ultimate vacuum with exhaust tube at outlet.

**** PC 3001 VARIO^{pro} without condenser: Hose nozzle with silencer

***** PC 3001 VARIO^{pro} without condenser: 12.2 (6.9)

Type		PC 3001 TE VARIO ^{pro}	PC 3001 VARIO ^{pro} emission condenser Peltronic
Inlet		hose nozzle for tubing I.D. 1/2" (hose nozzle DN 13 mm)	hose nozzle for tubing I.D. 1/4" / 3/8" (hose nozzle DN 6/10 mm)
Outlet		hose nozzle for tubing I.D. 3/8" (hose nozzle DN 10 mm)	hose nozzle for tubing I.D. 5/16" (hose nozzle DN 8 mm)
Permissible range of coolant temperature	°F (°C)	-112 to 68 (-80 to +20)	-
Coolant capacity	quarts (ml)	0.3 (275)	-
Dimensions L x W x H approx.	in (mm)	13.2 x 10.2 x 18.9 (335 x 260 x 480)	11.8 x 14.6 x 15.7 (300 x 370 x 400)
Weight approx.	lbs. (kg)	18.1 (8.2)	24.9 (11.3)

Controller	CVC 3000
Pressure transducer	ceramic diaphragm (alumina), capacitive, absolute pressure, gas type independent
Display	LCD graphic display, illuminated
Pressure units / scale (selectable)	Torr, mbar or hPa
Measuring range (absolute)	810 - 0.1 Torr (1080 - 0.1 mbar)
Maximum control range with internal pressure transducer (absolute)*	795 - 0.1 Torr (1060 - 0.1 mbar)
Resolution	0.07 Torr (0.1 mbar)
Maximum permissible pressure at pressure transducer (absolute)	1125 Torr (1.5 bar)
Maximum permissible temperature of gaseous media**	continuous operation: 104°F (40°C), for short periods (less than 5 minutes) up to 176°F (80°C)
Measurement uncertainty (absolute) after careful adjustment and at constant temperature	<± 0.75 Torr (1 mbar)
Temperature coefficient	<± 0.05 Torr/K (0.07 mbar/K)
Ambient temperature range (operation)	50°F to 104°F (10°C to +40°C)
Ambient temperature range (storage)	14°F to 158°F (-10°C to +70°C)
Permissible relative atmospheric moisture during operation (no condensation)	30% to 85%
Maximum permitted current of connected valves (connected components)	4A
Degree of protection IEC 529 (front side)	IP 42
Venting connection	hose nozzle for hose I.D. 3/16" (4-5 mm)
Maximum admissible pressure at venting connection	17.4 psi (1.2 bar) absolute
Interface	RS-232 C

* The actual vacuum control range in your application might be reduced due to ultimate vacuum of the pump, volume of gas present, etc.

** if pumping potentially explosive atmospheres: 50 °F to 104 °F (+10°C to +40°C)

NOTICE

See manual of Peltronic emission condenser for technical data!

We reserve the right for technical modification without prior notice!

Gas inlet temperatures

Operating condition	Inlet pressure	Permitted range of gas temperatures at inlet
Continuous operation	> 75 Torr (100 mbar) (high gas load)	➔ 50 °F to 104 °F (+10°C to +40°C)
Continuous operation	< 75 Torr (100 mbar) (low gas load)	➔ 32 °F to 140 °F* (0°C to +60°C*)
Short-time (< 5 minutes)	< 75 Torr (100 mbar) (low gas load)	➔ 14 °F to 176 °F* (-10°C to +80°C*)

* if pumping potentially explosive atmospheres: 50 °F to 104 °F (+10°C to +40°C)

Wetted parts

Components	Wetted materials
Pump	
Housing cover	PTFE
Head cover	ETFE carbon fiber reinforced
Diaphragm clamping disc	ETFE carbon fiber reinforced
Diaphragm	PTFE
Valve	FFKM
Pumping unit	
Inlet pumping unit	PPS (PC 3001 VARIO ^{pro} IK: PP)
Outlet pumping unit	PET (PC 3001 without emission condenser: PTFE carbon reinforced)
Outlet pumping unit (PC 3001 VARIO ^{pro} emission condenser Peltronic)	ETFE / ECTFE
Tubing	PTFE
Screw-in fittings	ETFE / ECTFE
O-ring at the catchpot	FPM
Overpressure safety relief device at exhaust waste vapor condenser	Silicone rubber / PTFE film
Distribution head (inlet)	PPS glass fiber reinforced / PP (blind plug)
Waste vapor condenser IK / EK / TE, catchpot	Borosilicate glass
Emission condenser Peltronic	ETFE / ECTFE / PP / PA
Silencer	PBT / PVF / rubber
CVC 3000	
Sensor	Aluminum oxide ceramic
Sensor housing	PPS / glass fiber
Sensor seal	Chemically resistant fluoroelastomer
Venting valve seal	FPM

We reserve the right for technical modification without prior notice!

Abbreviations

EK:	Waste vapor condenser (emission condenser)
ETFE:	Ethylene/Tetrafluoroethylene
ECTFE:	Ethylene/Chlorotrifluoroethylene
FFKM:	Perfluoro elastomer
FPM:	Fluoroelastomer
IK:	Waste vapor condenser (inlet condenser)
PA:	Polyamide
PBT:	Polybutylene terephthalate
PET:	Polyethylene terephthalate
PP:	Polypropylene
PPS:	Polyphenylene sulfide
PTFE:	Polytetrafluoroethylene
PVF:	Polyvinyl fluoride
TE:	Dry ice waste vapor condenser

Pump parts

Position	Component
1	MD 1C VARIO chemistry diaphragm pump
2	CVC 3000 controller
3	Mains connection
4	ON/OFF switch
5	Inlet
6	Outlet
7	Gas ballast valve
8	Handle
9	Exhaust waste vapor condenser

Position	Component
10	Catchpot
11	Coolant inlet
12	Coolant outlet
13	Dry ice vapor condenser
14	Distribution head
15	Inlet condenser
16	Peltronic emission condenser
17	Overpressure safety relief device

PC 3001 VARIO^{pro}

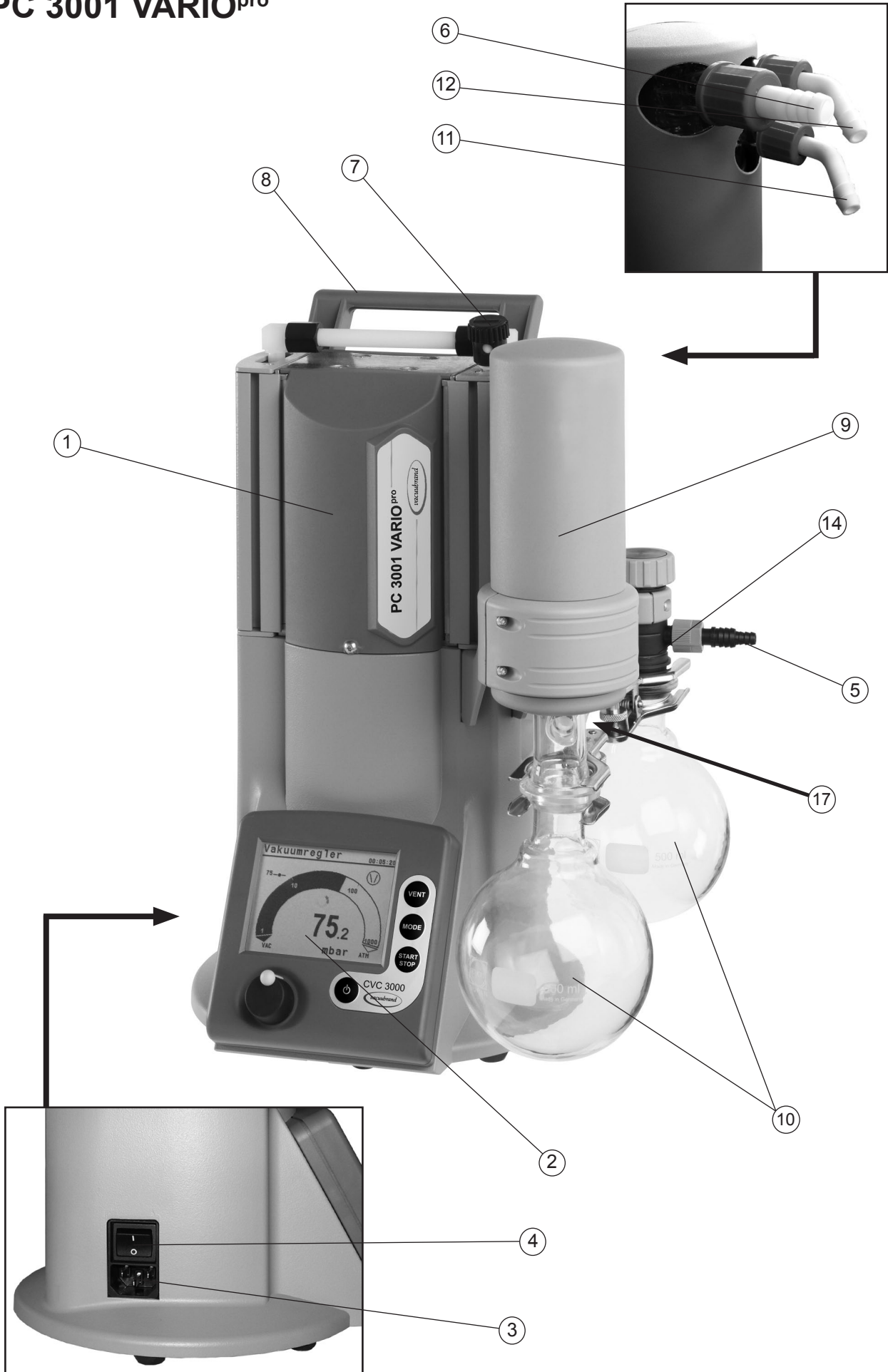

PC 3001 TE VARIO^{pro}



- 1
- 2
- 3
- 4
- 5
- 6
- 7
- 8
- 9
- 10
- 11
- 12
- 13
- 14
- 15
- 16
- 17

PC 3001 VARIO^{pro} IK

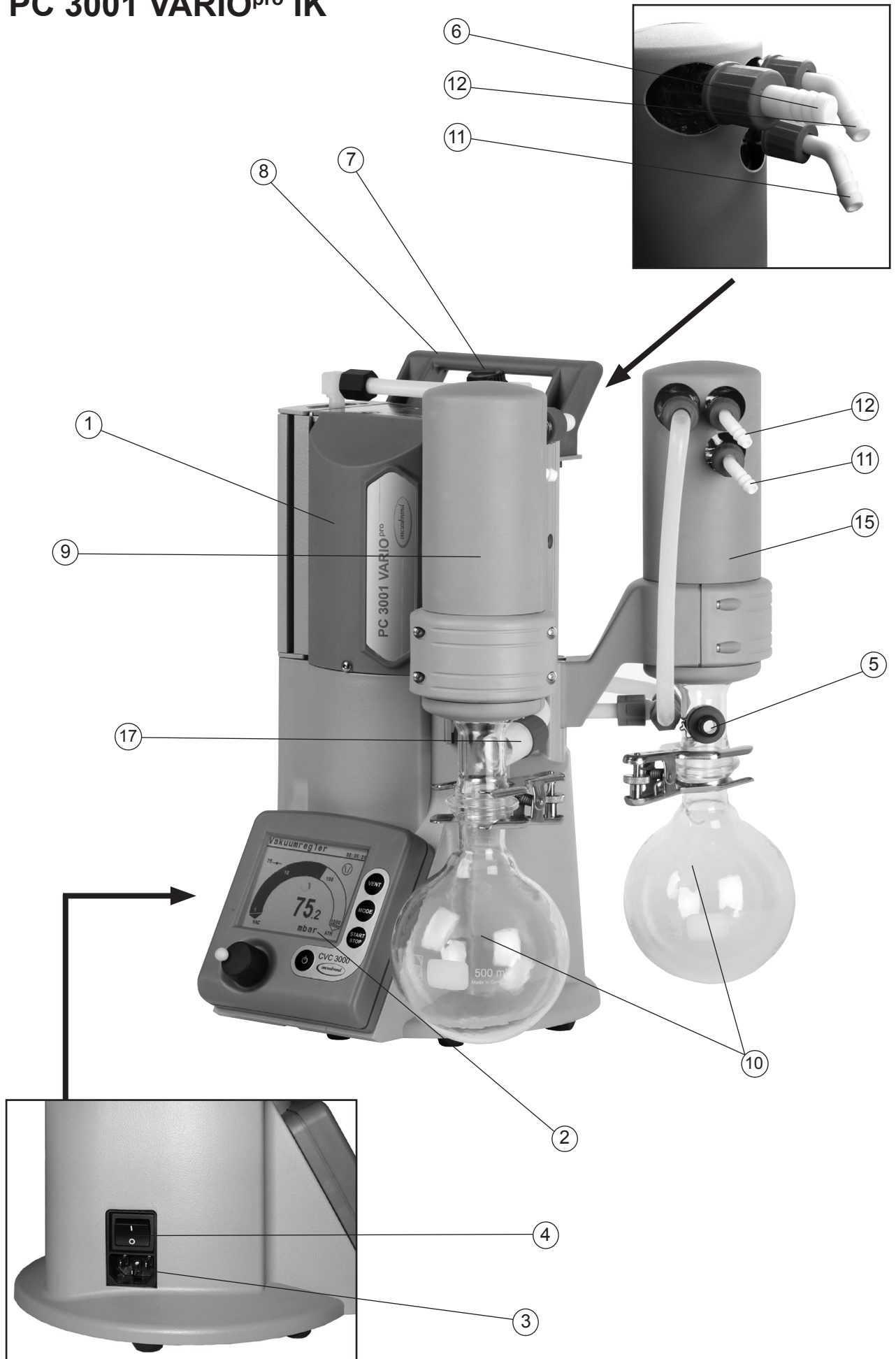

PC 3001 VARIO^{pro} emission condenser Peltronic

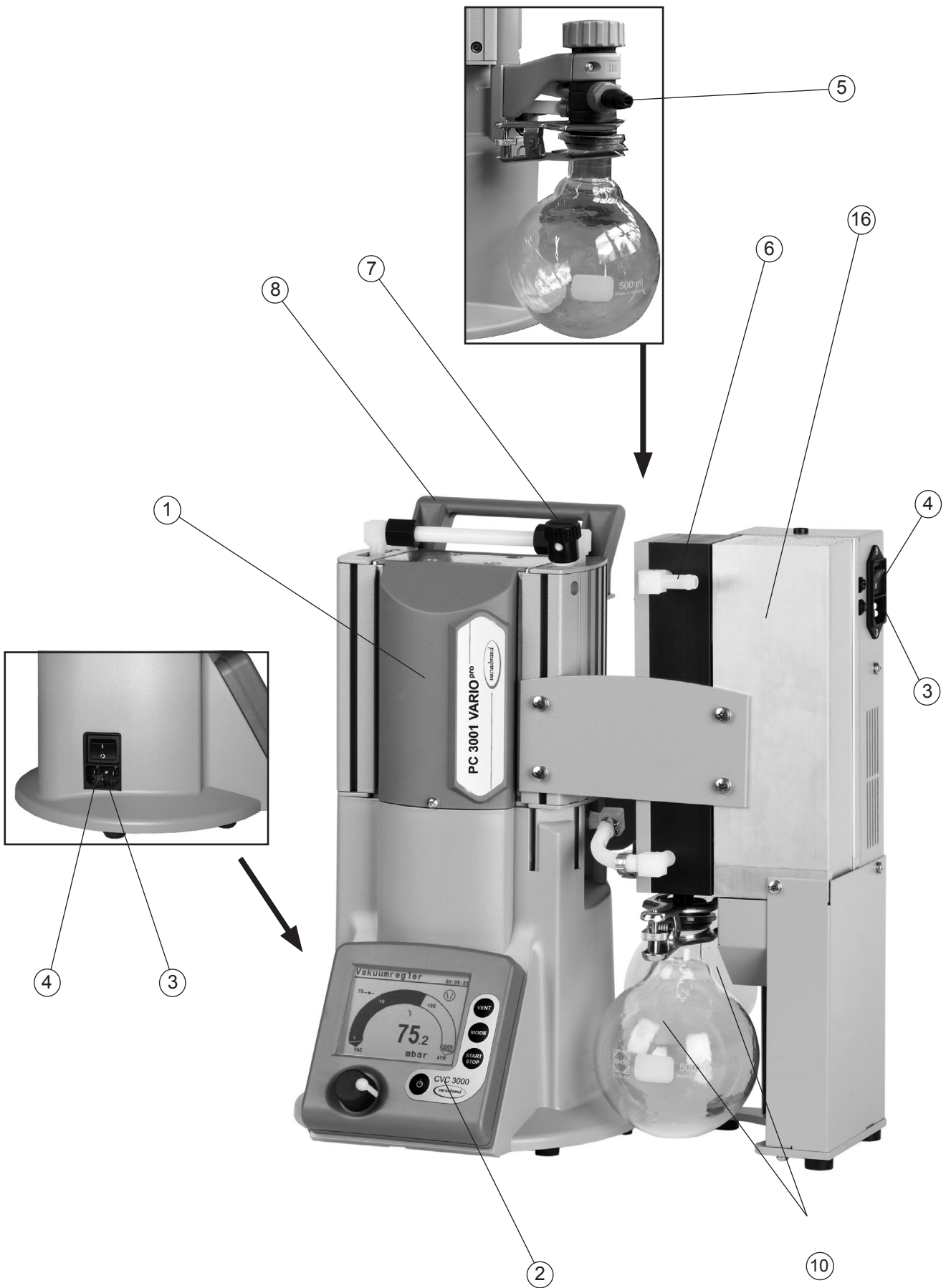

PC 3001 VARIO^{pro} (without exhaust waste vapor condenser)

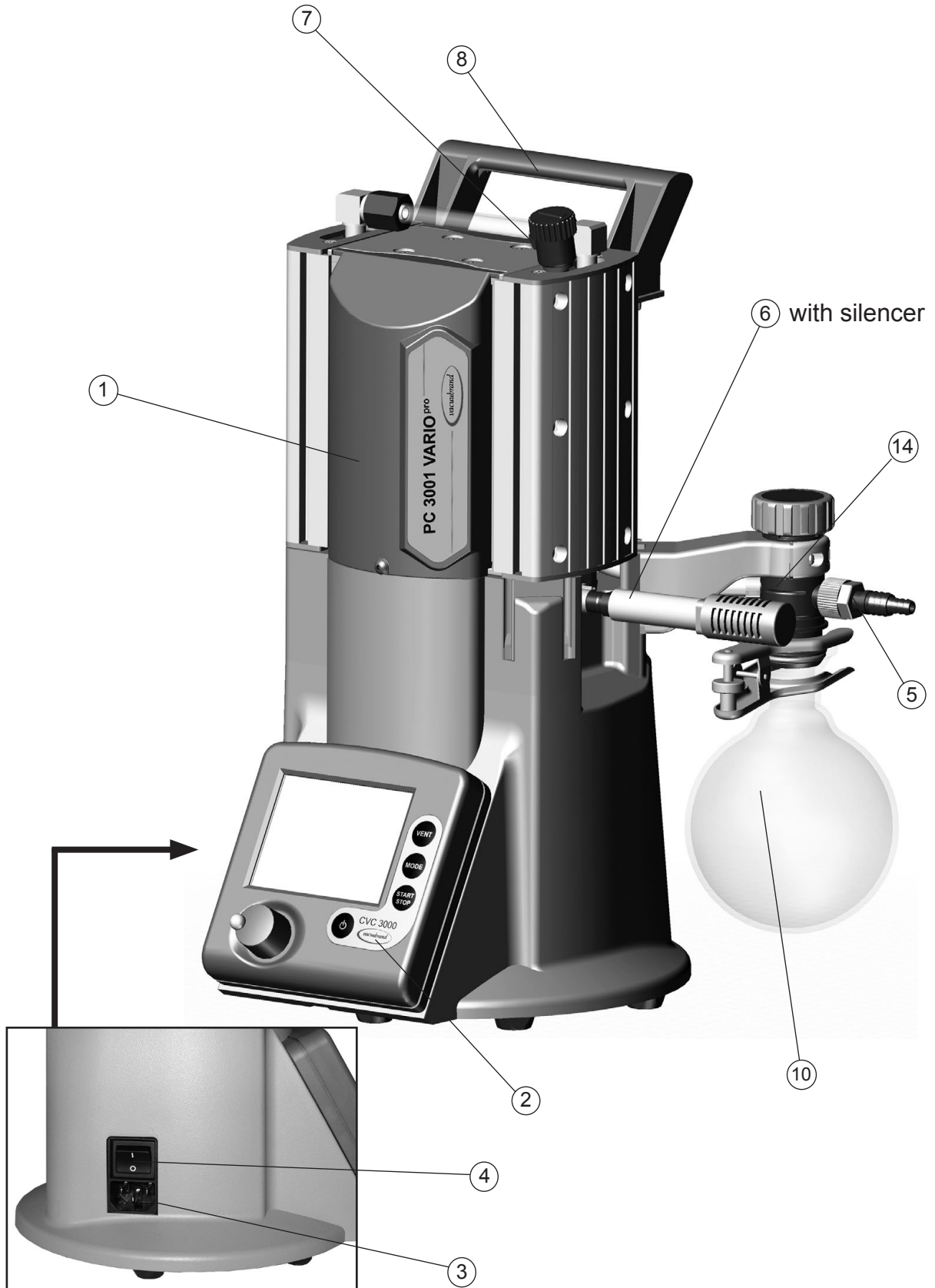

Rear side CVC 3000

jacks for connection of VACUU•BUS components (e.g., coolant valve)

connection plug of the VACUU • BUS line to VARIO pump

serial interface RS-232 C

venting connection



rating plate

measurement connection

Use and operation

When switching on the controller CVC 3000 for the very first time, a menu to select the language of the controller menu is displayed. Select the desired language (e.g., "English") by turning the selection knob and press to confirm. Then select the pressure unit ("mbar", "Torr" or "hPa") in the same way.

It is possible to access the language selection menu at any time by switching on the controller while keeping the selection knob pressed.

Installing a pump in a vacuum system



- ➔ If dangerous or polluting fluids could be released at the outlet, install an appropriate system to catch and dispose of those fluids.



- ➔ Connect a gas-tight exhaust line at the pump outlet if necessary. Always vent exhaust gases appropriately (e.g., into a fume hood).
- ➔ Never block the gas outlet. The exhaust line must always be free of obstructions (no back pressure) to ensure an unimpeded discharge of gas. The cross-section of the outlet tubing must be at least the size of the pump's exhaust connection.
- ➔ Maximum permissible pressure: 21.8 psi (1.5 bar) absolute.
- ➔ **Attention:** At pressures above approximately 795 Torr (1060 mbar) the pressure reading becomes incorrect due to saturation of the pressure transducer. The display will flash. Release pressure immediately! Risk of bursting!
- ➔ Particles and dust must not be aspirated. If necessary, you must install appropriate filters. You must ensure their suitability concerning gas flow, chemical resistance and resistance to clogging prior to use.

- ☞ Make sure ventilation is adequate, especially if the pump is installed in an enclosure, or if the ambient temperature is elevated. Provide external ventilation, if necessary.

CAUTION

- Reduce the transmission of vibration. Prevent mechanical load due to rigid pipelines. Insert elastic hoses or flexible elements as couplings between the pump and rigid pipes.
Note: Flexible elements will compress or flatten when evacuated if not designed for use under vacuum.
- Hose connections at the pump inlet must always be gas tight.
- A power failure may cause accidental ventilation of the pump, especially if the gas ballast valve is open. If this constitutes a potential source of danger, take appropriate safety measures.
- Check the power source and the pump's rating plate to be sure that the power source and the equipment match in voltage, phase, and frequency.

NOTICE

The ON/OFF switch is at the left side of the pumping unit.

After switching off the pump, wait minimum 60 sec. before switching on again.

Keep a distance of minimum 8 in (20 cm) between fan/pumping unit and adjacent equipment or casework.

Use connecting hoses with large diameter and keep them as short as possible to avoid flow losses. Locate the pump as closely as possible to the application.

Always install outlet tubing descending from the pump to avoid backflow of condensate towards the pump.

Use a suitable valve to isolate the pump from the vacuum application. This is to allow the pump to warm up before pumping condensable vapors and to clean the pump after use before it is switched off.

When assembling, ensure **vacuum-tightness**. After assembly, check the whole system for leaks.

Secure hose connections at the pump appropriately, e.g., with hose clamps, to protect against accidental detachment.

To reduce pump noise emanating from the pump exhaust port, connect an exhaust hose or use a silencer (see „Accessories“, pg. 94).

The VACUUBRAND controller CVC 3000 can only be operated with components compatible with the VACUUBRAND VACUU•BUS system, (see „Accessories“, pg. 94).

The vacuum controller CVC 3000 controls VACUUBRAND diaphragm pumps NT VARIO and VARIO-B, pumping units PC 30xx VARIO, and optional coolant and venting valves. Connected components (e.g., venting valve, level sensor, external pressure transducer 3000 series) are automatically identified and configured. Identical components must be configured beforehand; information upon request.

Do not use more than one controller within the same VACUU•BUS system.

Several controllers in the same VACUU•BUS system will interfere with each other and result in error messages of the connected components (pumps, valves).

CVC 3000

The CVC 3000 is equipped with an internal capacitive pressure transducer with ceramic diaphragm. It measures the actual pressure independently of the gas type, and with reference to the vacuum, i.e., absolute.

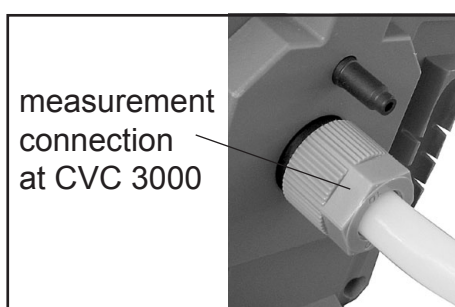

- Condensate and deposits will affect the measurement results. Clean the pressure transducer, if necessary. See section „Cleaning the pressure transducer“, pg. 83.

Connecting components at the controller:



At the rear side of the controller are connections for e.g., an optional coolant valve and/or an external pressure transducer and/or an external venting valve, as well as a venting connection and the serial interface RS 232C.

- Pull the controller out of the housing. Be careful not to disconnect the measuring connection (PTFE tube)!
- Insert the cable of the component to be connected underneath the housing and plug into the controller. Do not apply off-axis forces when assembling or removing plug connections! Observe correct orientation of the plug.
- Insert controller into the housing.

Separator at inlet and exhaust waste vapor condenser:

Assembling the hose nozzle with union nut:

- ➔ Take the hose nozzle with attached compression ferrule and union nut out of the catchpot and put onto inlet connection.
- ➔ Tighten the union nut by hand until you can feel the stop. Then tighten an additional 1/4 rotation with an open-ended wrench (size 17mm) for final installation.

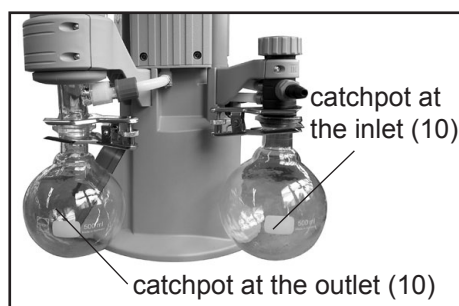

Catchpots:

The catchpot at the inlet protects against droplets and particles from entering the pump.

- ☞ Enhances lifetimes of diaphragms and valves.
- ☞ Improves vacuum performance in applications with condensable vapors.

Both catchpots are coated with a protective layer to protect against shattering in case of breakage or implosion.

- ➔ Assemble the catchpots at the inlet and at the outlet using joint clips.

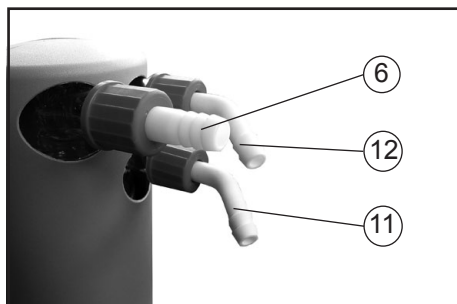

Exhaust waste vapor condenser (PC3001 VARIO^{pro}):

- ➔ Assemble the hose nozzles for coolant inlet (11) and coolant outlet (12) tubing and for the gas outlet (6) at the exhaust waste vapor condenser.

The **exhaust waste vapor condenser** enables an efficient condensation of the pumped vapors at the outlet.

- ☞ No backflow of condensates.
- ☞ Controlled recovery of condensates.
- ☞ Close to 100% solvent recovery.
- ☞ The isolation cover protects against glass splinters in case of breakage, acts as thermal insulation to avoid condensation of humidity and is intended to absorb shocks.

- ➔ Attach the tubing of the coolant circuit to the respective hose nozzles (hose nozzles for tubing I.D. 1/4"-5/16" (6-8 mm), see image) at the waste vapor condenser.

NOTICE

Check all hose connections prior to starting operation of the cooling system.

Secure coolant hoses at the hose nozzles (e.g., with hose clamps) to prevent their accidentally slipping off.

! DANGER

- ➔ Prevent the discharge of dangerous gases and vapors to the surrounding atmosphere. If appropriate, connect the exhaust line to a suitable treatment system.

! WARNING

- ☞ Never block the gas outlet ((8) hose nozzle for tubing I.D. 3/8" (10 mm)). The exhaust hose has always to be unobstructed and without back pressure to enable an unhindered discharge of gases and protect the pump valves from damage.

CAUTION

- **Note:** Install the hoses of the cooling system in a way to avoid the flow / dripping of condensed water onto the pumping unit (especially cables and electronic parts, see also IP degree of protection, „Technical data“, pg. 27).
- Ensure that the **coolant outlet tubing** is always unobstructed and that it cannot get blocked.
- Maximum permissible coolant pressure at the exhaust waste vapor condenser: 87 psi (6 bar) absolute. Outlet flow must always be unhindered.
- Comply with the maximum permissible coolant pressures of additional components in the coolant circuit (e.g., coolant valve).
- Avoid overpressure in the coolant circuit (e.g., caused by blocked or squeezed coolant hoses).
- Only install the optional coolant valve in the supply line of the exhaust waste vapor condenser.

Notes regarding the (dry) ice condenser (PC 3001 TE VARIO^{pro})



The **exhaust waste vapor condenser** enables an efficient condensation of the pumped vapors at the outlet.

- ☞ Close to 100% solvent recovery.
- ☞ The isolation cover protects against glass splinters in case of breaking, acts as thermal insulation to avoid the condensation of humidity and is intended to absorb shocks.

DANGER

- ➔ Adopt suitable measures to prevent the formation of explosive or flammable mixtures, use inert gas for venting if necessary.
- ➔ Prevent the discharge of dangerous gases and vapors to the surrounding atmosphere. If appropriate, connect the exhaust line to a suitable treatment system.
- ➔ Adopt suitable measures to prevent the release of dangerous, toxic, explosive, corrosive, noxious or polluting fluids, vapors and gases when disposing of condensates.

! WARNING

- ☞ Cold surfaces can absorb a great amount of gas, which may expand abruptly in case of warming. This may lead to unmanageable overpressure in the system, creating a risk of bursting!
- ☞ Check the coolant level of the condenser at appropriate intervals.
- ☞ **Attention:** Coolant may overflow unexpectedly, e.g., in case of large amounts of gas.
- ☞ Do not overfill the condenser. Lowest permissible coolant temperature: -112°F (-80°C).
- ☞ Maximum operating pressure: 16 psi (1.1 bar) absolute.
- ☞ Never block the gas outlet ((6) hose nozzle for tubing I.D. 3/8" (10 mm)). The exhaust hose has always to be unobstructed and without back pressure to enable an unhindered discharge of gases and protect the pump valves from damage.

! CAUTION

- Prior to every use: Inspect the condenser for faults. There must be no damage on the glass surfaces. Do not use damaged components.
- Use only transport receptacles intended for coolants.
- Use safety glasses and protective gloves.
- Do not clamp the covers of condensers or coolant receptacles. Allow pressure equalization between coolant and atmosphere.
- Comply with all applicable safety measures and requirements when using cryogenic coolants.

NOTICE

Use the equipment **only as intended**, that is, for condensation of vapors at the pump outlet or inlet.

Suitable coolants: e.g., dry ice or ethanol-dry ice mixture or water-ice mixture.



- ➔ Remove cap. Fill coolant into the coolant chamber. Put cap back in place. Do not clamp the cap.
- ☞ Check coolant level at appropriate intervals.
- ➔ Check level of condensate at appropriate intervals and drain condensate if necessary.
- ☞ Wait until the condensate has liquefied, if necessary.



- ☞ Separate the inner part of the condenser from the vacuum installation to drain the coolant.
- ➔ Remove the cap on top of the condenser. Turn the inner part of the condenser and lift to pull it out. Comply with regulations when disposing of chemicals.
- ☞ When reassembling check for the correct position of the seal between inner and outer parts of the condenser.

Notes concerning the operation of the inlet condenser IK

! WARNING

- ☞ **Attention:** The inlet condenser has **no overpressure safety relief device**.

! CAUTION

- **Note:** Install the hoses of the cooling system in a way to avoid the flow / dripping of condensed water onto the pumping unit (especially cables and electronic parts), or use thermally insulated hoses to prevent condensation.
- Ensure that the **coolant outlet tubing** at both condensers is always unobstructed and that it cannot get blocked.
- Water pressure shock at the condensers may cause breakage of the condenser coil!

Notes concerning the operation of the Peltronic emission condenser

NOTICE

Read the manual of the Peltronic emission condenser and observe the instructions contained in that manual!

Assembling the Peltronic emission condenser:



- Assemble the Peltronic emission condenser with two attachment screws (Phillips screwdriver size 2) to the pumping unit (a).
- Assemble the hose connection between pump outlet and condenser inlet (b).
- Slip connecting tube onto hose connection of the Peltronic emission condenser. Secure with hose clip.

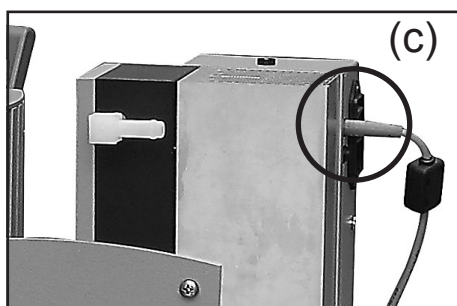

- Connect the VACUU•BUS cable from the CVC 3000 controller to the Peltronic emission condenser (c).

Notes concerning the operation of pumping units with silencer

NOTICE

Attention: Dust-laden gases, deposits and condensed solvent vapor can restrict air flow out the silencer. The resultant back pressure can lead to damage of pump bearings, diaphragms, and valves. Under those conditions, a silencer must not be used.

During operation

DANGER

- Vent and dispose of **potentially dangerous gases or vapors** at the outlet of the pump appropriately.

WARNING

☞ Due to the high compression ratio, the pump might generate overpressure at the outlet. Check pressure compatibility with system components (e.g., exhaust tubing or exhaust valve) at the outlet. Ensure that the pump outlet is neither blocked nor restricted.

☞ **Maximum ambient temperature:** 104 °F (40 °C)

Check the maximum temperatures, if installing the pump in a cabinet or a housing. Make sure ventilation is adequate, especially if the ambient temperature is elevated.

CAUTION

- If the pump is installed at an altitude of more than 6500 ft (2000 m) above mean sea level, check compatibility with applicable safety requirements, and adopt suitable measures. There is a risk of the motor overheating due to insufficient cooling.
- Check compatibility with the **maximally permitted pressure** at outlet and the **maximum pressure difference** between inlet and outlet ports.

NOTICE

Do not start the pump if the **pressure difference between inlet and outlet ports exceeds max. 16.0 psi (1.1 bar)**. Attempts to start the pump at higher pressure difference may cause stalling and damage of the motor.

If pumping condensable vapors (water vapor, solvents, etc.), let the pump run with **gas ballast** to help purge any condensation in the pump.

Prevent internal condensation, transfer of liquids or dust. The diaphragms and valves will be damaged, if liquids are pumped in significant amounts.

Check the pump regularly for external soiling and deposits. Clean the pump if necessary to avoid an increase of the pump's operating temperature.

Operation with silencer (optional) at the outlet: Operating the pump at a high inlet pressure or pumping dusty gases for a long time may cause clogging of the silencer. Check

the silencer regularly and replace if necessary.

A temperature sensor at the circuit board protects the motor: Current limitation in the event the temperature at the circuit board raises above 158°F (70°C). At temperatures above 185°F (85°C) the pump is switched off. In the event of a motor blockage (after 10 start-up attempts) the pump is switched off.

Note: Only manual reset is possible. Disconnect the pump from the power source. Identify and eliminate the cause of failure.

Check ventilation slots regularly for dust/dirt. Clean if necessary. Avoid overheating (e.g., due to hot process gases).

A warm up period (approximately 15 min.) is required to ensure that the rated ultimate vacuum and pumping speed are attained.

Important notes regarding the use of gas ballast

Gas ballast is a continuous purge to keep the pump's interior as clean as possible and to reduce the possibility of condensation inside the pump.

! DANGER

➔ Air and pumped media might react inside the pump or at the outlet of the pump and form hazardous or explosive mixtures, when you use air rather than inert gas for the gas ballast. This constitutes a risk of significant damage to equipment and/or facilities, a risk of personal injury or even loss of life.

! WARNING

☞ Make sure that air/gas intake through the gas ballast valve can never lead to hazardous, explosive or otherwise dangerous mixtures. If in doubt, use inert gas.

NOTICE

To reduce condensation in the pump, do not pump vapor before the pump has reached its operating temperature. Open the gas ballast valve when pumping condensable vapors. Turn gas ballast cap to open valve.

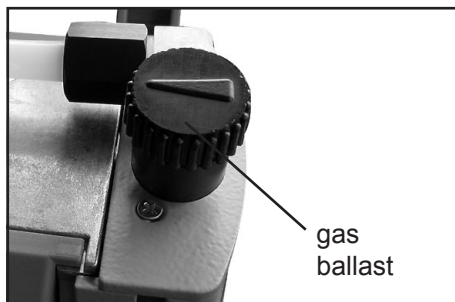

For **condensable vapors** (water vapor, solvents, etc.):

- The gas ballast valve is open if the arrow on the gas ballast cap is pointing towards the pump.
- With gas ballast valve open, the ultimate vacuum will be reduced.
- Use inert gas for gas ballast to avoid the formation of explosive mixtures. **Attention:** maximum supply pressure of inert gas: 17.5 psi (1.2 bar) absolute.
- Close the gas ballast valve by turning the cap 180°.

In case of low boiling solvents (when the formation of condensate is unlikely), the use of gas ballast might be unnecessary. Operating the pump without gas ballast increases the solvent recovery rate at the exhaust waste vapor condenser.

Important notes concerning the operation of the exhaust waste vapor condenser

! DANGER

- ➔ Connect the exhaust to a suitable treatment system to prevent the discharge of dangerous gases and vapors to the surrounding atmosphere.

! WARNING

- ☞ Never block the gas outlet ((6) hose nozzle for tubing I.D. 3/8" (10 mm)). The exhaust hose must always be unobstructed and without back-pressure to enable an unhindered discharge of gases.
- ☞ Check the overpressure safety relief device (17) at the exhaust waste vapor condenser (9) regularly; replace if necessary. Check especially for deterioration, coalescence and cracks.

CAUTION

- Ensure that the **coolant outlet hose** is always free and that it cannot get blocked.
- Maximum permissible coolant pressure at the exhaust waste vapor condenser: 87 psi (6 bar) absolute
- Comply with the maximum permissible coolant pressures of additional components in the coolant circuit (e.g., coolant valve).
- We strongly recommend installing an optional coolant valve (see „Accessories“, pg. 94) **in the supply line** of the exhaust vapor condenser to save water and reduce the risk of water spill.
- Avoid overpressure in the coolant circuit (e.g., caused by blocked or kinked coolant hoses).
- Avoid any clogging of the exhaust vapor condenser caused by deposits or frozen solvents. Clean if necessary or use higher coolant temperatures.

NOTICE

In case of **condensation**: Check the liquid level in both catchpots (10) during operation. Check the liquid level regularly. Do not allow the catchpots to overflow. Drain catchpots in time to avoid overflow. Install a level sensor (see „Accessories“, pg. 94) for monitoring, if necessary. The maximum liquid level is at approximately 80% of the total filling level to avoid problems when removing the catchpots.

Permissible range of coolant temperature at the exhaust waste vapor condenser:

5 °F to 68 °F (-15°C to +20°C)

Check hose connections prior to starting operation of the cooling system.

Check coolant hoses regularly during operation.

Removing the catchpots:

Stop process.

Catchpot at outlet:

Remove joint clip. Remove catchpot and drain condensate.

Catchpot at inlet:

Admit air or inert gas (via the pump inlet) to restore atmospheric pressure in the catchpot before attempting removal.. Remove joint clip. Remove catchpot and drain condensate.

NOTICE

Reattach drained catchpots.

WARNING

☞ **Important:** Comply with regulations when disposing of solvents/condensates. Recycle if possible; purify if contaminated.

Shutdown & storage

The pump can be switched off under vacuum.

NOTICE

Short-term:

Has the pump been exposed to condensate?

- Allow the pump to continue to run at atmospheric pressure for a few minutes.

Has the pump been exposed to media which may damage the pump materials or form **deposits**?

- Check and clean pump heads if necessary.

Has the pressure transducer been exposed to media which may form deposits?

- Clean pressure transducer at the CVC 3000 controller if necessary.

Long-term:

- Take measures as described above regarding short-term shutdown.
- Separate the pump from the application.
- Close inlet and outlet ports (e.g., with transport caps).
- Close the gas ballast valve.
- Drain catchpots.
- Store the pump under dry conditions.

CVC 3000 Vacuum controller

When switching on the CVC 3000 controller for the very first time, a menu to select the language of the controller menu is displayed. Select the desired language, e.g., "English" by turning the selection knob and pressing to confirm. Then select the pressure unit ("mbar", "Torr" or "hPa") in the same way.

It is possible to access the language selection menu at any time by switching on the controller while keeping the selection knob pressed.

After switching on the device, the **version number of the software** is displayed, followed by the preselected function and the pressure reading.

Attention: Do not assemble or remove plug connections off-axis! Orient the plug correctly before inserting. To connect additional components use VACUU•BUS Y-adapters and extension cables. If an external pressure transducer is connected, it is recognized automatically. Further information on how to use several sensors simultaneously is available upon request.

Keys

VENT:

- A short tap vents momentarily; process continues.
- Pressing longer than 2 seconds vents the system to atmospheric pressure (to 788 Torr (1050 mbar) at maximum); process stops.

MODE:

- Selects menu "function"
- Use for temporary switching during operation to other functions

Start or Stop the process

ON/OFF switch

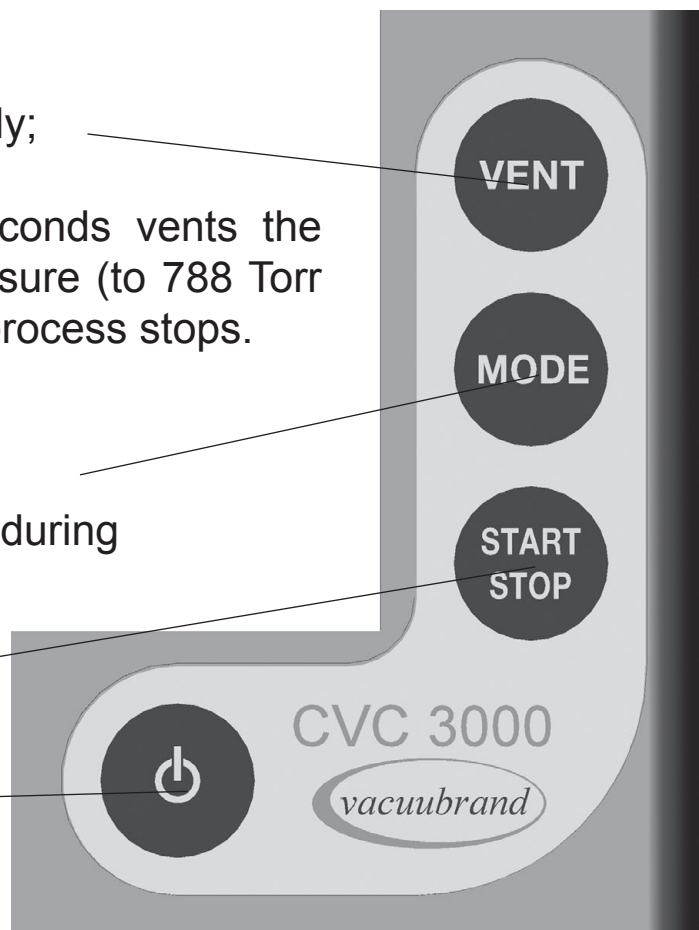

Selection knob

- Press to reach the set-up menu of the function
- Turn to choose the parameter you want to modify
- Press to select the parameter you want to modify
- Turn to change the set value of the parameter
- Press to confirm change of value and to reach further parameters, or to leave the set-up menu

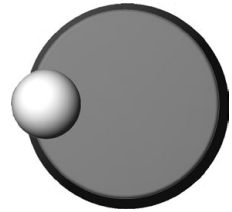

Display and symbols

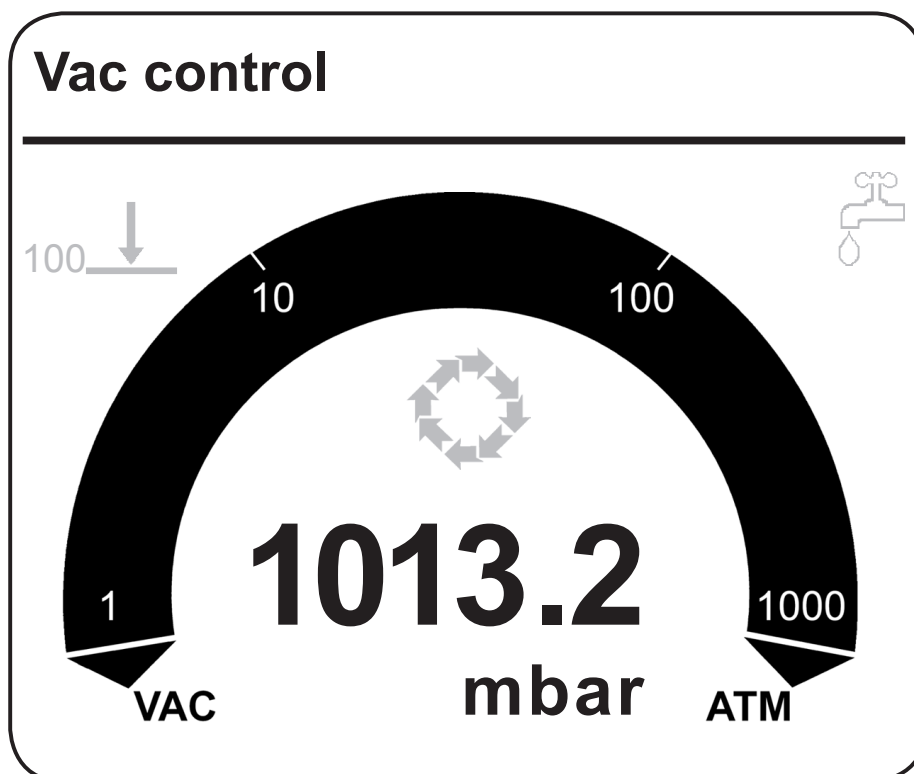

Selected function (displayed in the upper left corner):

















A "function" is one of the following operation modes of the CVC 3000 controller:

Pump down / Vac control / Auto mode (only with VACUU•BUS-compatible VARIO pump) / Program / VACUULAN / Configuration

Other display symbols:

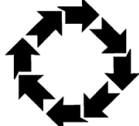
1013.2 Actual absolute pressure at the pressure transducer

mbar / Torr / hPa Preselected pressure unit

100  / 100 	Vacuum control to a preset vacuum value (here: 100 mbar/Torr/hPa); (without / with VACUU•BUS-compatible VARIO pump)
 / 	Actual pressure is in the range "Set vacuum + hysteresis" (without VACUU•BUS-compatible VARIO pump) / Actual pressure = "Set vacuum" (with VACUU•BUS-compatible VARIO pump)
	Flashing: The actual pressure is greater than the preset maximum value (" <i>Maximum</i> ")
	Minimum value (" <i>Minimum</i> ") reached
00:00:00	Process runtime (only if process control is running)
	Pump down (continuous pumping)
50% 	Pump symbol is displayed when pump is running. With a VACUU•BUS-compatible VARIO pump, the pump's motor speed is also displayed in % of full speed.
5 	Time meter is running (in function "VACUULAN"); remaining time in minutes is displayed
	In-line valve switched on
	Venting valve switched on
	Coolant valve switched on
	PC symbol: controller is in remote operation
	Control is running
	Warning notice (if necessary in combination with other symbols), flashing
	Level sensor activated; catchpots need to be emptied.
	Peltronic emission condenser connected

Notes on selecting the function

The CVC 3000 controller can be adapted to the specific application by choosing the appropriate function depending on the connected components and the requirements of the application.

Automatic detection of the components

When switching on the controller, the configuration of the connected components is checked automatically.

Connected components (e.g., VACUU•BUS-compatible VARIO pumps, gauge heads 3000 series, valves, level sensors) are **detected automatically** and controlled by the CVC 3000 until the controller is switched off. Identical components must be configured beforehand; information upon request. Switch the controller off and on again to renew the configuration.

The last mode of operation and the preselected values (e.g., for pressure, speed or time for automated switching off) are stored.

If the preselections are chosen appropriately, it is possible to start immediately if similar operating conditions are desired.

The controller features **five functions and one configuration menu**, see section "Menu guide". Each of these functions involves different menu options, which are presented automatically and reflect the connected components. **The types of components connected (e.g., valves) determine the active menu items.**

Changing the function:

- ➡ Switch controller on.
- ➡ Press "START/STOP" key to terminate control in case control is running (e.g., if "Autostart" is activated).
- ➡ Press "MODE" key.
- ➡ Select function with knob and press to confirm.

☞ Depending on the selected function and system components, the controller provides different operating control, as follows:

"Pump down"

- Manages the continuous speed control of the VACUU•BUS-compatible VARIO pump depending on preselected pressure and time settings.
- Coolant valve

”Vac control”

- With pressure preselection, controls a VACUU•BUS-compatible VARIO pump to maintain pinpoint control of that pressure.
- Coolant valve

”Auto mode”

- Provides fully automatic boiling point determination and adaptation with pinpoint precision, and optimization of pumping speed with VACUU•BUS-compatible VARIO pumps.
- Coolant valve

”Program”

- Control pump based on time and pressure preselections, or ”Auto mode”.
- Coolant valve
- Venting valve

”VACUULAN”

- Use continuous speed control to manage VACUU•BUS-compatible VARIO pumps, based on pressure and time preselections.
- Coolant valve

”Configuration”

Preselections for

- Adjustment of the pressure transducer
- Interface RS-232
- Sensors (configuration and switching between several sensors)
- Display (brightness and contrast of the display, language, sound)
- Autostart (automatic restart after power failure)
- Defaults (reset the controller to factory set values)

Menu guide

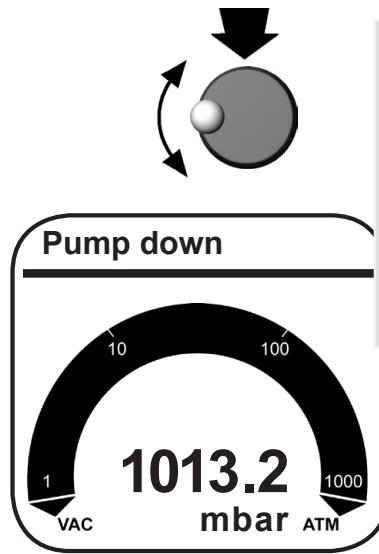
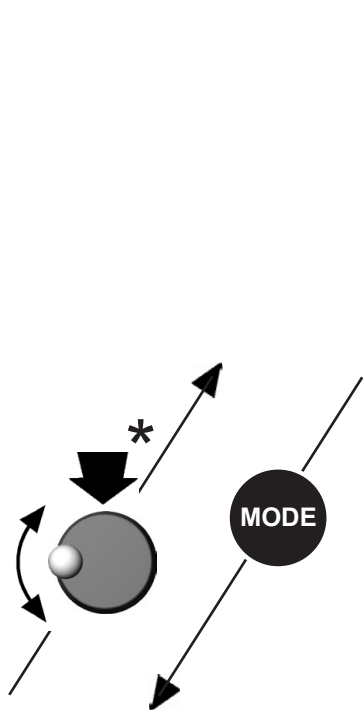

Pump down	
Speed	HI
Minimum	Off
Delay	Off
Duration	Off
----- Graphic -----	
----- Back -----	

Function

- Pump down
- Vac control
- Auto mode
- Program
- VACUULAN
- Configuration

----- Back -----

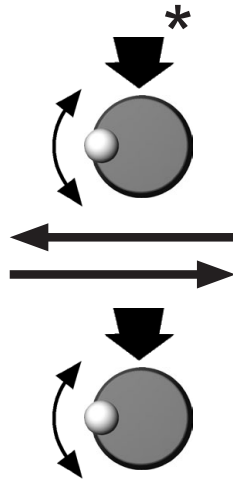

Configuration

Adjustment	743 Torr
RS-232...	
Sensors...	
Display...	
Autostart	Off
Defaults	Cancel

----- Back -----

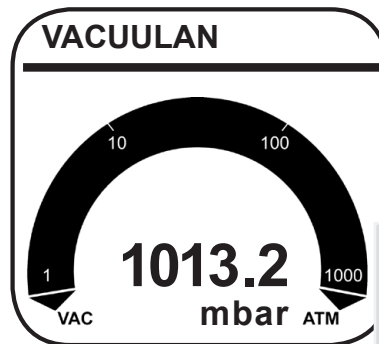
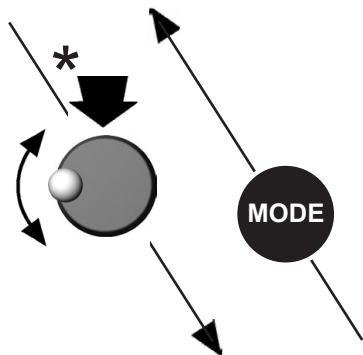

VACUULAN	
Set vacuum	19 Torr
Switch on	150 Torr
Delay	15 min
----- Graphic -----	
----- Back -----	

* : or automatically after 20 seconds without action

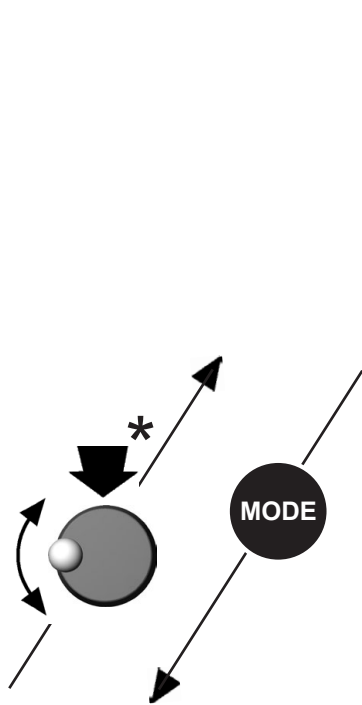

Vac control

Vac control	
Set vacuum	75 Torr
Speed	HI
Maximum	Off
Delay	Off
Duration	Off
----- Graphic -----	
----- Back -----	

Function
Pump down
Vac control
Auto mode
Program
VACUULAN
Configuration
----- Back -----

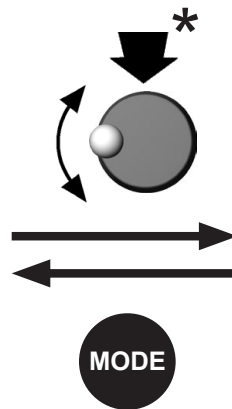

Auto mode

Auto mode	
Sensitivity	normal
Speed	HI
Minimum	Off
Delay	Off
Duration	Off
----- Graphic -----	
----- Back -----	

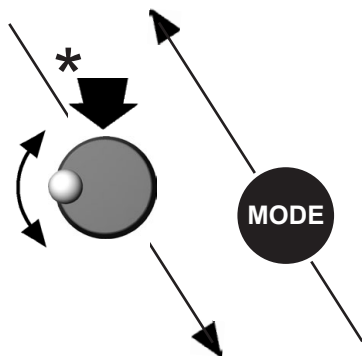

Program

Program	
Edit	
Open	0
Store	0
Delay	Off
----- Graphic -----	
----- Back -----	

* : or automatically after 20 seconds without action

Pump down function

Function definition:

➔ Continuous pumping with pressure and time settings

- Operation on demand of a speed controlled VACUU•BUS-compatible VARIO pump

Preselections

☞ Use the selection knob to select the parameters. All parameters can be altered even while operation control is running.

☞ **Speed:** Preselection of the motor speed for pump down. The selection "HI" effects the maximum speed and best ultimate vacuum of the pump (with automatic speed reduction at ultimate vacuum). The "Speed" is adjustable in a range of 1-100% and to "HI".

☞ **Minimum:** The controller switches the pump off once the preset value for "Minimum" has been reached.

"Minimum" is adjustable in a range of 1-795 Torr (1-1060 mbar) or can be set to "Off".

A preset "Duration" (process time) has no effect if the process is stopped due to a preset "Minimum" before "Duration" is reached.

☞ **Delay:** "Delay" determines the time the coolant valve remains open after the process has been stopped.

The "Delay" is adjustable in a range of 1-300 minutes or can be set to "Off" ("Off" means that the coolant valve closes immediately when the process stops.).

☞ **Duration:** "Duration" determines the total process time since control start.

The process time is adjustable between 1-1440 minutes (24 h) or can be set to "Off". "Off" indicates that no endpoint for pump down is determined.

If a "Duration" is preset, the controller switches off the pump when the preset process time is reached, even if a preset "Minimum" is still not reached.

- ☞ If neither "*Minimum*" nor "*Duration*" is preset, process control has to be stopped by pressing key "STOP".

The screen-shot shows the factory-set values.

Pump down	00:00:00
Speed	HI
Minimum	Off
Delay	Off
Duration	Off
----- Graphic -----	
----- Back -----	

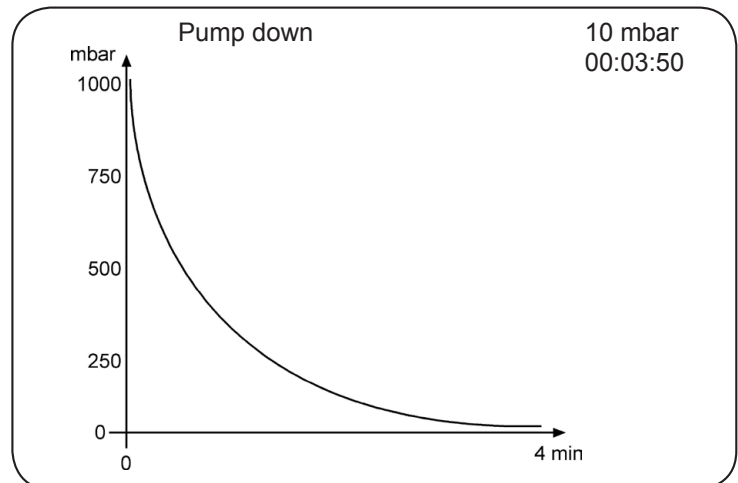

When selecting "*Graphic*" the display shows a pressure vs. time curve.

The timeline in the diagram adapts automatically to the process time.

- ☞ Press the selection knob twice to return to the standard display.

Temporary switching from "Pump down" to "Vac control" or "Auto mode" (only if control is running):

- ☞ Press "MODE" key. The controller switches to "Vac control" function, the current vacuum is used as set value.
- ☞ Pressing "MODE" key again switches to "Auto mode" function. The controller adapts the boiling pressure starting from the current vacuum level.
- ☞ The preset function of the controller does not change due to this temporary switching. When pressing "STOP" key, the controller is set again to the "Pump down" function.

Adapting the pumping speed during pump down:

- ☞ Press the selection knob and turn.
- ☞ Turning the knob to the left reduces the speed.
- ☞ Turning the knob to the right increases the speed.

Vac Control function

Function definition:

➔ **Vacuum control to a preset vacuum value**

- **Operation on demand of a speed controlled pump (VACUU•BUS-compatible VARIO pump)**

Preselections

- ☞ Use the selection knob to select the parameters. All parameters can be altered even while operation control is running.
- ☞ **Set vacuum:** The "Set vacuum" is the set point for vacuum control with pinpoint precision for VACUU•BUS-compatible VARIO pumps. The "Set vacuum" is adjustable in a range of 1-795 Torr (1-1060 mbar) or can be set to "Turbo". The selection "Turbo" leads to the optimum backing pressure for a turbomolecular pump.
- ☞ **Speed:** The maximum motor speed can be preselected (to control the pumping speed). The "Speed" is adjustable in a range of 1-100% or can be set to "HI". The selection "HI" (recommended) provides the optimum pumping speed of the pump and therefore an optimum ultimate vacuum.
- ☞ **Maximum:** An upper pressure limit can be preselected. The pump switches off if the pressure limit is exceeded, e.g., at the end of suction or filtrations. The pressure limit is only active once the pressure has gone below "Maximum". The "Maximum" is adjustable in a range of 794-1Torr (1059 - 1 mbar) (at the least 1 Torr (mbar) higher than the "Set vacuum") and to "Off". "Off" means that no "Maximum" value is preset.
- ☞ **Delay:** "Delay" determines the time the coolant valve remains open after the process has been stopped. The "Delay" is adjustable in a range of 1-300 minutes or can be set to "Off" ("Off" means that the coolant valve closes immediately when the process stops.).
- ☞ **Duration:** "Duration" determines the total process time since control start.

A preset "Duration" (process time) has no effect if the process is stopped due to a preset "Maximum" before "Duration" is reached.

The "Duration" is adjustable between 1-1440 minutes (24 h) or can be set to "Off". "Off" means that no endpoint of the process is defined.

The screen-shots show the factory-set values.

Vac control	00:00:00
Set vacuum	75 Torr
Speed	HI
Maximum	Off
Delay	Off
Duration	Off
----- Graphic -----	
----- Back -----	

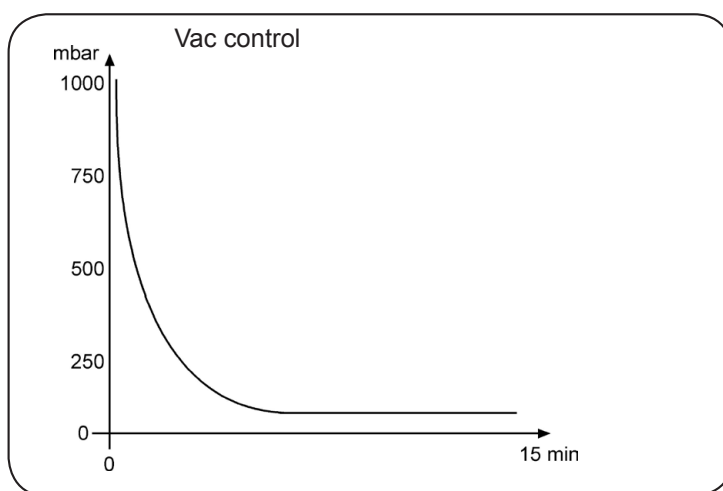

When selecting "Graphic" the display shows a pressure vs. time curve.

The timeline in the diagram adapts automatically to the process time.

☞ Press the selection knob twice to return to the standard display.

Temporarily switching from "Vac control" to "Auto mode" while process control is running:

☞ Press "MODE" key. The controller switches to "Auto mode" and adapts the boiling pressure starting with the actual set value. The preset function of the controller does not change due to this switching. When pressing the "STOP" key, the controller is in "Vac control" function again.

Adjustment of the set vacuum during vacuum control:

Dynamic, interactive adaptation:

☞ Press the selection knob and keep pressed.

☞ Turning the knob for a 1/4 turn to the left causes pump down.

☞ Turning the knob for a 1/4 turn to the right causes venting.

☞ When the knob is released, the current pressure value is used as new set value.

Alternatively:

Fine tuning:

The set vacuum can be fine-adjusted by turning the selection knob while process is running.

- ☞ Turn the selection knob.
- ☞ A full turn causes a change of the set vacuum of 9 Torr (12 mbar).
- ☞ Turning the knob one detent causes a change of the set vacuum of 1 Torr (mbar).

Auto mode

Function definition:

➔ **Control of a VACUU•BUS-compatible VARIO pump in "Auto mode":**

Automatic detection of boiling points, and automatic adjustment of determined boiling points as process parameters change.

Preselections

☞ Use the selection knob to set the parameters.

☞ **Sensitivity:** The "*Sensitivity*" of the control determines the control speed. The "*Sensitivity*" is adjustable to "high", "normal" or "low".

High sensitivity leads to a reduced pump-down speed, e.g., for small amounts of solvents or foaming processes. Use a low sensitivity for "non-critical" processes to reduce process time. Usually setting the "*Sensitivity*" to "normal" is appropriate.

☞ **Speed:** The maximum motor speed can be preselected (to limit the pumping speed).

The "*Speed*" is adjustable in a range of 1-100% or can be set to "HI". The selection "HI" (recommended) causes an automatic limitation of the adaptation depending on parameters determined during the process. Only in case of very sensitive processes is it advisable to reduce the maximum speed.

☞ **Minimum:** If the vacuum value reaches "*Minimum*" the process is stopped. Use "*Minimum*" for automatic process termination.

The "*Minimum*" is adjustable in a range of 2-795 Torr (2 - 1060 mbar), or can be set to "Auto" or to "Off".

When selecting "Auto" the controller switches off automatically at the end of the process (boiling plateau). This is recommended only for large amounts of solvents.

☞ **Delay:** "*Delay*" specifies the time the coolant valve remains open after process stop.

The "*Delay*" is adjustable in a range of 1-300 minutes or can be set to "Off" ("Off" means that the coolant valve closes immediately when the process stops.).

☞ **Duration:** "Duration" determines the total process time since control start.

The "Duration" is adjustable between 1-1440 minutes (24 h) or can be set to "Off". A preset "Duration" (process time) has no effect, if the process is stopped earlier by reaching the preset "Minimum".

The screen-shot shows the factory-set values.

Auto mode	00:00:00
Sensitivity	normal
Speed	HI
Minimum	Off
Delay	Off
Duration	Off
----- Graphic -----	
----- Back -----	

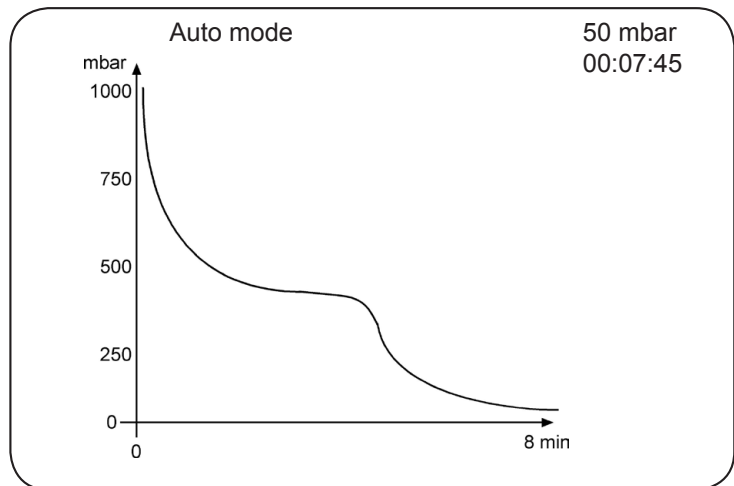

When selecting "Graphic" the display shows a pressure vs. time curve.

The timeline in the diagram adapts automatically to the process time.

☞ Press the selection knob twice to return to the standard display.

Temporary switching from "Auto mode" to "Vac control" function

☞ Press "MODE" key. The controller switches to "Vac control". The current pressure value is used and held as new set point.

☞ The preset function of the controller does not change due to this temporary switching. When pressing "STOP" key, the controller is set again to the "Auto mode".

Program function

Function definition:

➔ **Permits ten programs to be defined and stored, each with up to ten program steps with preset values for vacuum and time.**

👉 **Edit:**

Use to define the preset values for the process run:

Time: Defines either the process runtime for each program step to reach a preset vacuum level or, if programming a "Step", the runtime after having achieved the vacuum level. The total process runtime is shown in the base line. Attention: A preset runtime of 99:59:59 hours in the final program step will cause the process to run endlessly. Terminate the process by pressing the "STOP" key .

Vacuum: Vacuum level to be attained.

Venting valve: Operating a venting valve to reach a preset vacuum level.

"Step": "Step" causes pump down as fast as possible to the preset vacuum level. As soon as the vacuum level is reached the time meter starts running.

"Auto": Auto = \downarrow : indicates that the system will search for a boiling point automatically, and will automatically adapt to changes in the boiling point until a preselected time interval expires.

Auto = \rightarrow : indicates that the system will automatically adapt to changes in the boiling point. The program step is finished when the selected time or pressure value has been reached.

Selecting "Auto" in combination with "Step" in one program step is not possible.

👉 **Open:** Choose program (Programs 0 - 9).

👉 **Store:** This command stores an edited program or the program of the last process to one of the storage spaces 0 - 9.

👉 **Delay:** "Delay" specifies the time the coolant valve remains open after process stop.

The "Delay" is adjustable in a range of 1-300 minutes or can be set to "Off" ("Off" means that the coolant valve closes immediately when the process stops.).

Editing:

- ☞ To select row: turn and press selection knob.
- ☞ To adjust parameter: turn the selection knob.
- ☞ To confirm parameter: Press selection knob. Controller will accept change and jump to the next parameter in the same row.
- ☞ After 5 seconds without a change, the parameter is assumed to be the current setting. Select the next row to edit or return to the Program menu.
- ➔ In case, store an edited program after having quit "Edit" by storing it to one of the storage spaces 0 - 9 (select "Store").

The screen-shot shows the factory-set values.

Program	00:00:00
Edit	
Open	0
Store	0
Delay	Off
----- Graphic -----	
----- Back -----	

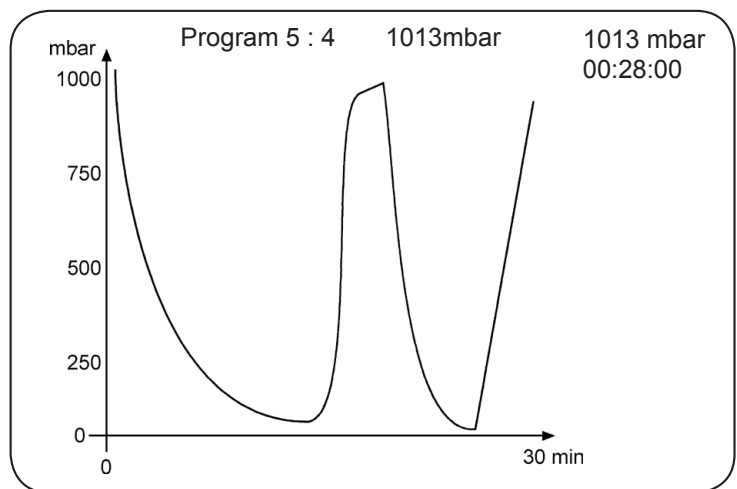

When selecting "Graphic", the display shows a pressure vs. time curve.

Program number, and the step number in that program, along with the vacuum setting, the actual current pressure and the actual runtime are displayed across the top.

The timeline in the diagram adapts automatically to the process time.

- ☞ Press the selection knob twice to return to the standard display.

The most recent process (except in "VACUULAN" function) is stored in the temporary data memory as long as the controller stays switched on. This program can be transferred to a storage space and edited.

Once the program is finished, the clock symbol starts to flash. Confirm the end of the program by pressing START/STOP (clock symbol will disappear).

Attention: If "**Autostart**" is set to "**On**", the **program will start again (time will be reset to 00:00:00) after a power failure or after switching the controller off/on**. Only if the end of the program (clock symbol flashing) has been confirmed by pressing START/STOP, the program will not start again.

Attention: If the controller is set to "Defaults": "On", all stored programs will be deleted.

Application example

Example

VACUU•BUS-compatible VARIO vacuum pump with speed control (e.g., with a rotary evaporator): Degassing and automatic distillation with timing

Program					
No	hh:mm:ss	Vac	Vent.	Step	Auto
01	00:00:00	ATM	✓	✓	
02	00:10:00	300		✓	
03	01:00:00	2			↓*
04	00:01:00	ATM	✓	✓	
05	00:00:00	0			
06	00:00:00	0			
07	00:00:00	0			
08	00:00:00	0			
09	00:00:00	0			
10	00:00:00	0			
----- Back -----					
01:11:00					

* If the pressure difference between the vacuum for degassing and the expected vacuum for distillation is very small (distillation vacuum >75% of the degassing vacuum), select the function "Auto ←" (adapting the vacuum starting from the current pressure) instead of "Auto ↓" (at first searching the boiling point automatically, and then adapting the vacuum).

Program step 1 should be always a definite initial state, here atmospheric pressure (ATM). To reach this state definitely, set a tickmark at "Vent." and "Step" by pressing the selection knob.

In step 2, pumping begins, attempting to reach 300 Torr/mbar as quickly as possible ("Step"). Vacuum holds there for 10 minutes (degassing the solvent).

In step 3, "Auto ↓" causes an automatic search of a boiling point in the pressure interval between 300 Torr/mbar/hPa (depending on preset pressure unit) and 2 Torr/mbar/hPa, followed by automatic adaptation to changes in the boiling point. The following step starts either (1) once the cumulative process time reaches the set limit (1 hour/60 minutes), even if the preset pressure (2 Torr/mbar/hPa) has not been reached, or (2) if a vacuum of 2 Torr/mbar/hPa is reached, even if the preset time has not been completed.

Step 4 vents to atmospheric pressure as fast as possible and switches off the control after one minute.

VACUULAN function

Function definition:

- ➔ **Optimizes vacuum control for vacuum networks**
(e.g., VACUUBRAND VACUU•LAN)
- ➔ **Permits on-demand operation of a speed-controlled pump**
(VACUU•BUS-compatible VARIO pump)

Preselections

☞ Use the selection knob to select the parameters.

☞ **Set vacuum** (the lower switch-off value): If the pressure drops below the "Set vacuum", a time-meter starts to run and the motor speed is reduced. When the pressure exceeds the "Set vacuum" pressure again, the time meter is reset. If the "Set vacuum" is not reached within 100 hours, the controller signals an error.

The "Set vacuum" is adjustable in the range of 1-795 Torr (1-1060 mbar).

☞ **Switch on** (the higher switching value): If the pressure exceeds this pressure, pumping down starts again.

The "Switch on" pressure is adjustable in the range of 2-795 Torr (2-1060 mbar).

In the event of a sudden high-pressure spike, pumping starts again even if the "Switch on" pressure has not been reached (pressure increase control).

☞ **Delay**: If the vacuum is below "Set vacuum" for longer than the "Delay" time, the pump is stopped. Pumping starts again in the event of a rapid pressure increase or if the "Switch on" level is exceeded.

The "Delay" is adjustable in a range of 1-300 minutes or can be set to "Off" ("Off" means that the pump stops immediately when the pressure drops below "Set vacuum").

This screen-shot shows the factory-set values.

VACUULAN	00:00:00
Set vacuum	19 Torr
Switch on	150 Torr
Delay	15 min
----- Graphic -----	
----- Back -----	

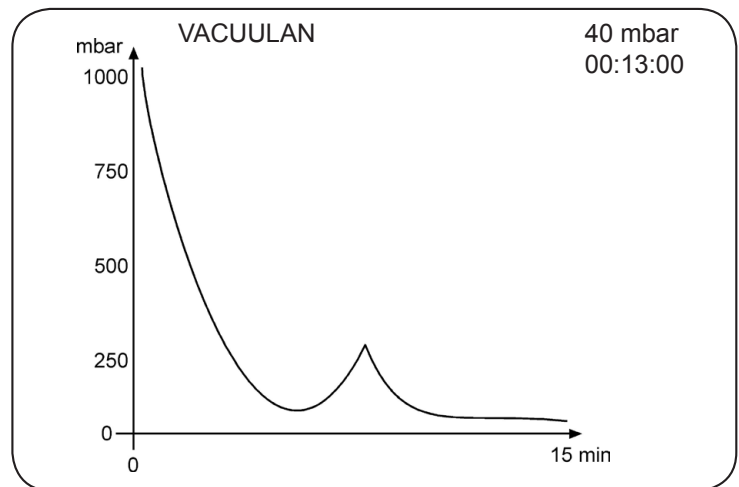

When selecting "*Graphic*" the display shows a pressure vs. time curve.

The timeline in the diagram adapts automatically to the process time.

👉 Press the selection knob twice to return to the standard display.

Application examples

Assembly of a vacuum system

- ☞ Assemble the vacuum connection line between the vacuum pump and the vacuum application.
- ☞ Assemble the vacuum connection line between the controller and the vacuum application, if the controller is not part of a pumping unit.
- ☞ Assemble electrical connections.
- ☞ Connect coolant if necessary.

Vacuum for filtration and suction

- ☞ Select "**Pump down**" function.
- ☞ If necessary, set value for "*Speed*" (high or low pumping speed). Reduce the speed in case of fast sedimentation (formation of a filter cake).
- ☞ Set "*Minimum*" to a value which provides adequate suction but does not lead to evaporation of the solvent.
- ☞ Start process by pressing "START/STOP" key.

alternatively:

- ☞ Select "**Vac control**" function.
 - ☞ Set "*Set vacuum*" to a value which does not lead to evaporation of the solvent.
 - ☞ If necessary, set value for "*Speed*" (high or low pumping speed). Reduce the speed in case of fast sedimentation (formation of a filter cake).
 - ☞ Set "*Maximum*" pressure setting so that pump will switch off at the end of the filtration process, or in the event that a filter cake cracks, leading to a sudden pressure increase.
 - ☞ Start process by pressing "START/STOP" key.
- ☞ **Tip for filtration:** Adjust preset pressure to a value well above the boiling pressure of the solvent (e.g., for water >>15 Torr (20 mbar)). Set the maximum pressure to e.g., 375 Torr (500 mbar). Once the filtration has finished, the pressure increases and the pump is switched off automatically.

Vacuum for gel dryer, drying chambers and vacuum concentrators

- ☞ Select function "**Pump down**" function. "*Speed*" "HI" is recommended. For gel dryers set a lower speed if necessary (if the gels tend to crack).
- ☞ Set "*Minimum*" to prevent volatile components from evaporating. The process is stopped automatically as soon as "*Minimum*" is reached.
- ☞ Set a process time ("*Duration*") if necessary.
- ☞ Start process by pressing "START/STOP" key.

alternatively:

- ☞ Select "**Vac control**" function to dry at a predetermined vacuum level.
- ☞ Set "*Set vacuum*" to the preferred evaporation vacuum of the solvent.
- ☞ Set a process time ("*Duration*") if necessary.
- ☞ Start process by pressing "START/STOP" key.

Vacuum for distillation and evaporation (e.g., rotary evaporator)

Fully automatic determination and adaptation of the boiling point with a VACUU•BUS-compatible VARIO pump (recommended)

- ☞ Select "**Auto mode**".
- ☞ Start process by pressing "START/STOP" key.
- ☞ The "Auto mode" allows a fully automatic distillation even if the boiling vacuum is unknown. With solvent mixtures, the vacuum is reduced until all solvents or volatile components are evaporated (with respect to the ultimate vacuum of the pump and the bath temperature).
- ☞ If "*Minimum*" is set, the controller switches off the pump when the pre-set vacuum value is reached. The "*Minimum*" should be well below the boiling vacuum of the solvent to be evaporated and above the ultimate vacuum attainable in the apparatus. If the "*Minimum*" is set to "Auto", the controller automatically switches off the pump at the end of the evaporation (recommended for large solvent quantities only). The setting of "*Duration*" (process runtime) has no effect if the pump is switched off due to "*Minimum*" before "*Duration*" is over.

- ☞ When setting a value for "*Duration*" the controller switches off the pump when "*Duration*" has passed even if a preset "*Minimum*" is still not reached.
- ☞ If neither "*Minimum*" nor "*Duration*" is preset, pumping down has to be finished by pressing the "START/STOP" key.

alternatively:

Semi-automatic distillation and evaporation

- ☞ Select function "**Pump down**".
- ☞ Start process by pressing "START/STOP" key.
- ☞ Observe process. As soon as evaporation starts, press "MODE" key (switching to "Vac control"). The vacuum level is kept constant (at the boiling pressure). Fine tuning of the vacuum value is possible by turning the selection knob.
Pressing "MODE" key a second time switches to "Auto mode" causing the vacuum level to be automatically adapted to changes of the boiling pressure.

alternatively:

- ☞ Select "**Vac control**" function.
- ☞ Set a maximum "Speed", to select a faster or slower process.
- ☞ To set "Maximum" is usually not necessary, unlike filtrations, because the pressure does not increase at the end of the evaporation.
- ☞ Set a value for "*Duration*" if the process should be terminated automatically after a definite time.
- ☞ Set "*Set vacuum*" depending on the solvent and the temperature.
- ☞ Start process by pressing "START" key.
- ☞ **To temporarily switch to "Auto mode"**: Press "MODE" key. The controller switches to "Auto mode". The setting of the controller does not change due to this switching. After pressing "START/STOP" key the controller is in "Vac control" again.

Vacuum for VACUU•LAN networks

- ☞ Select function "**VACUULAN**".
- ☞ Set "*Set vacuum*" to a pressure which can be reached reliably in the vacuum network. Take account of the ultimate vacuum of the pump and of the system's leak rate in case of no vacuum demand.
- ☞ Set "*Switch on*" pressure appropriately to ensure sufficient vacuum for all connected applications.
- ☞ Set "*Delay*" if necessary.
- ☞ Start process by pressing "START/STOP" key.

Configuration

In the "Configuration" menu the device parameters are preselected. After 20 seconds without action the function "Configuration" and its sub-menus (except submenu "Sensors") are quit automatically without storing any possibly changed parameter.

Preselections

- ☞ Use the selection knob to select the parameters.
- ☞ **Adjustment:** Adjustment of the pressure transducer under vacuum and/or at atmospheric pressure, see also section „Readjustment of CVC 3000“, pg. 80.
Adjustment to atmospheric pressure is carried out at an absolute pressure value between 795 - 525 Torr (1060 - 700 mbar). This is especially helpful in high elevation laboratories. Adjustment under vacuum may be done at an absolute vacuum value between 0 - 15 Torr (0 - 20 mbar). In the range between 15 to 525 Torr (20 to 700 mbar) no adjustment is possible; ---- Torr is displayed.
- ☞ **RS-232:** Configuration of the interface, setting of parameters and commands, see section "Interface".
Baud rate can be set to 19200, 9600, 4800 or 2400, parity on "8-N-1", "7-O-1" or "7-E-1", Handshake on "no", "Xon-Xoff" or "RTS-CTS" and remote on "On" or "Off".
- ☞ **Sensors:** Selection of the pressure transducer to be controlled (maximum 4 external sensors).
- ☞ **Display:** Selection of the device parameters "Brightness" between 0 - 100%, "Contrast" between 0 - 100%, "Sound" "On" or "Off", "Units" "mbar", "hPa" or "Torr", "Language" "German", "English", "French", "Italian", "Spanish", "Turkish", "Korean", "Chinese", "Portuguese", "Russian", "Polish", "Dutch", "Japanese", "Finnish".
- ☞ **Autostart:** If "Autostart" is set to "On" the controller restarts a running process automatically after a power failure. If this is unwanted, set "Autostart" to "Off".



Attention: If "Autostart" is preselected, the process starts immediately after power failure without pressing any fur-

ther key. It is the user's responsibility to ensure that no dangerous status of the system due to the automatic start-up can occur and to provide appropriate safety measures. If necessary, the user has to check **prior to starting the process** if the option "*Autostart*" is enabled.

☞ **Defaults:** If "*Defaults*" is set to "Load", the controller is reset to factory set values. All stored programs and parameters are deleted.

This screen-shot shows the factory-set values.



The screenshot shows a configuration menu with the following items and values:

Configuration	
Adjustment	743 Torr
RS-232...	
Sensors...	
Display...	
Autostart	Off
Defaults	Cancel
----- Back -----	

Please continue with part 2 of this manual.



Technology for Vacuum Systems

Instructions for use

Part II of II



Part II:
Readjustment -
Interface parameters -
Accessories - Maintenance

PC 3001 VARIO^{pro}
PC 3001 TE VARIO^{pro}
PC 3001 VARIO^{pro} IK
PC 3001 VARIO^{pro} EK Peltronic

Chemistry pumping unit with speed control

Contents

Part I	1
Reset / Language selection	8
Safety information!	11
Important information!	11
General information.....	13
Intended use.....	13
Setting up and installing the equipment	14
Ambient conditions	16
Operating conditions	17
Safety during operation	19
Maintenance and repair.....	23
⚠ Important information: Equipment marking (ATEX)	25
Technical data	27
General technical data valid for all pumping units.....	27
Gas inlet temperatures	30
Wetted parts	30
Abbreviations.....	31
Pump parts	31
Use and operation	38
Installing a pump in a vacuum system	38
Notes regarding the (dry) ice condenser	43
Notes concerning the operation of the inlet condenser IK	45
Notes concerning the operation of the Peltronic emission condenser	46
Notes concerning the operation of pumping units with silencer	46
During operation.....	46
Important notes regarding the use of gas ballast	48
Important notes concerning the operation of the exhaust waste vapor condenser.....	49
Shutdown & storage.....	51
CVC 3000 Vacuum controller	52
Menu guide	57
Pump down function	59
Vac Control function	61
Auto mode	64
Program function	66
Application example	68

VACUULAN function	69
Application examples	71
Vacuum for filtration and suction	71
Vacuum for gel dryer, drying chambers and vacuum concentrators	72
Vacuum for distillation and evaporation (e.g., rotary evaporator)	72
Vacuum for VACUU•LAN networks	74
Configuration	75
Part II	77
Readjustment of CVC 3000	80
Calibration in the factory	82
Cleaning the pressure transducer	83
Interface parameters	84
Setting of the interface	85
Read commands "CVC 2000"	86
Write commands "CVC 2000"	87
Read commands "CVC 3000"	89
Write commands "CVC 3000"	91
Accessories	94
Troubleshooting	95
Replacing diaphragms and valves	99
Cleaning and inspecting the pump heads	101
Disassembling the housing cover at the side of the emission condenser.....	103
Replacing the diaphragm	105
Assembling the housing cover at the side of the emission condenser.....	108
Disassembling the housing cover at the side of the ON/OFF switch	108
Assembling the housing cover at the side of the ON/OFF switch	109
Assembling the fittings.....	109
Cleaning and replacing components	112
Notes on return to the factory	113
Warranty	116
Health and safety clearance form	117
EC Declaration of Conformity of the Machinery	118

Readjustment of CVC 3000

NOTICE

The vacuum gauge was adjusted using factory standards, which are traceable through regular calibration in an accredited laboratory (DAkkS calibration laboratory) to the German national pressure standard. Depending on the process and/or accuracy requirements, check the adjustment and readjust if necessary. For readjustment, the device has to be adjusted both at atmospheric pressure as well as under vacuum but only if the reference pressures are known with certainty. The adjustment mode can be activated only if the process control is inactive. Press "START/STOP" key, if necessary. In the range between 15 to 525 Torr (20 to 700 mbar) no adjustment is possible; ---- Torr is displayed.

Adjustment at atmospheric pressure

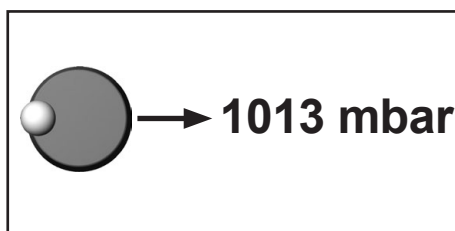

An adjustment at atmospheric pressure is only possible if the pressure is higher than 525 Torr (700 mbar).

Vent the measurement connection of the CVC 3000 and/or the vacuum system. Make sure that the pressure transducer is at atmospheric pressure.

- ➔ In "Configuration" menu, select program "Adjustment" at the controller.
- ➔ Use the selection knob to adjust the reading to the current atmospheric pressure.
- ➔ Press the selection knob to confirm.

Note: To determine the actual atmospheric pressure, use an accurate barometer or get accurate reading from the weather service, or a nearby airport or other reliable source (taking into account the difference in altitude between the source and the laboratory).

Adjustment under vacuum

0 mbar

An adjustment under vacuum is only possible if the pressure is lower than 15 Torr (20 mbar) absolute.

Evacuate the measurement connection of the CVC 3000 to a pressure < 0.1 Torr (mbar) (e.g. by applying a good two-stage rotary vane pump).

- ➔ In "Configuration" menu, select program "Adjustment" at the controller.
- ☞ The reading is automatically adjusted to "zero".
- ➔ Press the selection knob to confirm.

Note: Adjustment under vacuum with an actual pressure higher than 0.1 Torr (mbar) reduces the accuracy of the measurement. If the pressure is significantly higher than 0.1 Torr (mbar), adjustment to a reference pressure is recommended.

Adjustment at a reference pressure



Instead of adjustment under vacuum to a pressure < 0.1 Torr (mbar), adjustment to a precisely known reference pressure within the range of 0..... 15 Torr (20 mbar) is possible. Evacuate the measurement connection of the CVC 3000 to a pressure within 0 15 Torr (0.....20 mbar).

- ➔ In "Configuration" menu, select program "Adjustment" at the controller.
- ☞ The reading is automatically adjusted to "zero".
- ➔ Use the selection knob to adjust the display to the reference pressure at the vacuum line within the range of 0 15 Torr (0.....20 mbar).
- ➔ Press the selection knob to confirm.

Note: The accuracy of the value of the reference pressure will directly affect the accuracy of the adjustment. If the nominal ultimate vacuum of a diaphragm pump is used as reference vacuum, the accuracy of the controller might be doubtful. The diaphragm pump may not achieve the specified value (due to condensate, poor condition, failure of valves or diaphragm, leaks).

Calibration in the factory

Control of measuring equipment

The **VACUUBRAND DAkkS calibration laboratory** is accredited by the Deutsche Akkreditierungsstelle GmbH (national accreditation body of the Federal Republic of Germany) for the measurable variable **pressure in the pressure range from $7.5 \cdot 10^{-4}$ Torr to 975 Torr (10^{-3} mbar to 1300 mbar)** in accordance with the general criteria for the operation of testing laboratories defined in the DIN EN ISO/IEC 17025:2000 series of standards (accreditation number D-K-15154-01).

The DAkkS is signatory to the multilateral agreements of the European cooperation for Accreditation (EA) and of the International Laboratory Accreditation Cooperation (ILAC) for the mutual recognition of calibration certificates.

Rely on calibration in the VACUUBRAND calibration laboratory:

- To meet the requirements of the DIN ISO 9000ff and 10012 series of standards regarding the calibration of inspection, measuring and test equipment at specified intervals.
- To document that the vacuum gauges calibrated are traceable to national standards of the PTB (Physikalisch-Technische Bundesanstalt; German national institute for science and technology and the highest technical authority of the Federal Republic of Germany for the field of metrology and certain sectors of safety engineering).

To order **DAkkS calibration** of the CVC 3000 pressure transducer,
order number: **900217**

Cleaning the pressure transducer

- ➔ **Attention: Never use a pointed or sharp-edged tool to clean the pressure transducer.**
- ➔ **Never touch the ceramic diaphragm of the pressure transducer with hard objects.**
- ➔ Fill the measurement chamber with a solvent (e.g., benzene) and allow sufficient cleaning time. Observe all regulations concerning usage and disposal of solvents!
- ➔ Drain the solvent and dispose of in accordance with regulations. Repeat cleaning if necessary.
- ➔ Rinse the measurement chamber several times with alcohol in order to remove all solvent residues.
- ➔ Allow the pressure transducer to dry.
- ➔ Readjust the pressure transducer if necessary.

Readjustment of the controller CVC 3000

See section „Readjustment of CVC 3000“, pg. 80.

Interface parameters

The CVC 3000 controller is equipped with a serial interface (RS 232C, nine-pin Sub-D-plug).

- ☞ Plug-in or remove the cable (cable RS 232C) from the interface only if the equipment is switched off.
- ☞ The interface is **not** electrically isolated from the measuring circuit.
- ☞ For optimal electromagnetic compatibility assemble an interface filter (cat. no.: 638235).

The controller is fully operable via the serial interface. Measuring results, preselections and the status of the controller can be read at any time.

The factory-set read and write commands are completely compatible with the VACUUBRAND CVC 2000 controller (see sections "Read / Write commands CVC 2000"). An extended instruction set is available using the command "CVC 3" (see sections "Read / Write commands CVC 3000").

Setting of the interface

Set the interface parameters directly at the controller CVC 3000. The factory set values are underlined.

Edit and confirm the interface parameters in the "Configuration" menu in "RS-232" submenu using the selection knob.

- ➔ Baud: 2400, 4800, 9600 or 19200
- ➔ Parity: 8-N-1, 7-O-1 or 7-E-1
- ➔ Handshake: Off, Xon-Xoff or RTS-CTS
- ➔ Remote: On or Off
- ➔ Timeout: Sending 1s, receiving 10s.

In remote mode (Remote On, with the "PC symbol" in the display) all keys at the controller are inoperable.

To return to the manual operation of the controller, set the controller to "Remote off" in menu configuration: Switch off the controller. Then switch the controller back on, and press the selection knob within 2s.

- ➔ A maximum of ten commands per second is possible.
- ➔ Read commands and commands "REMOTE", "CVC", and "STORE" can always be sent. The sending of other write commands is only possible, if "Remote on" is selected.
- ➔ The commands have to be written in capital letters.
- ➔ Command and parameter have to be separated by a blank.
- ➔ The string is terminated with <CR> or <LF> or <CR><LF>.
- ➔ The response of the controller is always terminated with <CR><LF>.
- ➔ Numerical values and parameters can be written without leading zeros.
- ➔ The response of the controller always includes leading zeros.

Pin assignment RS-232 C

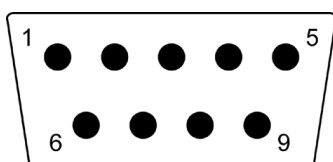

2: RxD
3: TxD
4: DTR

5: Mass
7: RTS
8: CTS

9: +5V (Bluetooth)

Read commands "CVC 2000"

Command	Operation	Response	Description
IN_PV_1	current pressure	XXXX mbar/ Torr/hPa	unit according to preselections
IN_PV_2	current frequency	XX.X Hz	pump speed
IN_CFG	device set preselections	0XXXX 1XXXX 2XXXX 3XXXX X0XXX X1XXX XX0XX XX1XX XXX0X XXX1X XXXX0 XXXX1	VACUU•LAN continuous pumping vacuum control without automatic vacuum control with automatic no coolant valve coolant valve no venting valve venting valve no automatic switch off automatic switch off remote operation off remote operation on
IN_ERR	error code	1XXX X1XX XX1X XXX1	fault at pump electronics overpressure maloperation mode pressure transducer last command to interface incorrect
IN_STAT	status of process control	0XXX 1XXX X0XX X1XX XX00 XX01 XX02 XX03 XX10 XX11 XX20 XX21 XX22 XX23 XX30 XX31 XX32 XX33	coolant valve closed coolant valve open venting valve closed venting valve open VACUU•LAN: inactive VACUU•LAN: pumping down, current pressure > selected pressure VACUU•LAN: pumping down, time for automatic switching off is running VACUU•LAN: system is switched off continuous pumping: not active continuous pumping; active vacuum control: not active vacuum control: current pressure above set vacuum vacuum control: current pressure equals set vacuum (± 1 Torr/mbar) vacuum control: current pressure below set vacuum automatic: not active automatic: determining boiling point automatic: adjusting boiling point automatic: system is switched off

Write commands "CVC 2000"

Command	Operation	Parameter	Description
OUT_MODE	function	1 2 3 30 31 32	continuous pumping vacuum control without automatic vacuum control with automatic <i>optional: sensitivity: low</i> <i>optional: sensitivity: normal</i> <i>optional: sensitivity: high</i>
OUT_SP_1	set vacuum	XXXX	unit (mbar/Torr/hPa) according to pre-selection; see respective function for parameter range
OUT_SP_V	set vacuum with venting*	XXXX	unit (mbar/Torr/hPa) according to pre-selection; see respective function for parameter range
OUT_SP_2	set frequency	XX.X	motor speed in Hz (99.9 for "HI"; 99.8 for 3000 rpm)
OUT_SP_3	vacuum for switch on (VACUU•LAN)	XXXX	unit (mbar/Torr/hPa) according to pre-selection; see respective function for parameter range
OUT_SP_4	delay	XX:XX	hh:mm (hours:minutes)
OUT_SP_5	vacuum for automatic switching off	XXXX	unit (mbar/Torr/hPa) according to pre-selection; see respective function for parameter range
OUT_SP_6	time for automatic switching off (VACUU•LAN)	XX:XX	hh:mm (hours:minutes)
START	starting process control		
STOP	stopping process control	1 2	termination of process control termination of process control and storage of the current pressure as new set point
REMOTE	remote operation**	0 1	set controller to local operation set controller to remote operation
OUT_VENT	driving venting valve	0 1	close venting valve (not automatically) open venting valve (process control stopped)

* Pressure setting with venting is only possible in "Vac control" function if a venting valve is connected and configured, and vacuum control is started. The venting valve opens automatically if the actual pressure is at least 7.5 Torr (10 mbar) below the preset pressure. Automatic venting becomes inactive if vacuum control is stopped (by pressing "START/STOP" or "VENT"), a pressure value is set using the command OUT_SP_1, or if the function is changed. Activate the command OUT_SP_V again if necessary.

- ** If remote operation is selected or deselected, the user has to ensure that no dangerous status of the system can occur due to the change of the mode of operation, and must take appropriate safety precautions, especially if selecting remote operation interferes with a locally operated active process.

Read commands "CVC 3000"

Command	Operation	Response	Description
IN_PV_1	current pressure	XXXX.X mbar/Torr/hPa	unit according to preselections
IN_PV_2	current speed	XXX%	1-100% or "HI"
IN_PV_3	time	XX:XX h:m	process runtime (hours:minutes)
IN_PV_X	pressure	XXXX.X XXXX.X ...	pressure of all connected sensors, unit (mbar/Torr/hPa) according to preselections
IN_PV_T	operation time of the controller	XXXXdXXh	operation time in days and hours
IN_CFG	device set preselections + Language: 0: German 1: English 2: French 3: Italian 4: Spanish 5: Turkish 6: Korean 7: Chinese 8: Portuguese 9: Russian A: Polish B: Dutch C: Japanese D: Finnish	0XXXXXXXXXXXXXXXXX VACUU•LAN 1XXXXXXXXXXXXXXXXX Pump down 2XXXXXXXXXXXXXXXXX Vac control 3XXXXXXXXXXXXXXXXX Auto mode 4XXXXXXXXXXXXXXXXX Program 5XXXXXXXXXXXXXXXXX measuring device XyXXXXXXXXXXXXXXXXX y: 0.....D: language+ (hexadecimal) XX0XXXXXXXXXXXXXXXXX pressure unit mbar XX1XXXXXXXXXXXXXXXXX pressure unit Torr XX2XXXXXXXXXXXXXXXXX pressure unit hPa XXX0XXXXXXXXXXXXXXXXX autostart off XXX1XXXXXXXXXXXXXXXXX autostart on XXXX0XXXXXXXXXXXXXXXXX acoustic signal off XXXX1XXXXXXXXXXXXXXXXX acoustic signal on XXXXX0XXXXXXXXXXXXXXXXX VARIO pump not connected XXXXX1XXXXXXXXXXXXXXXXX VARIO pump connected XXXXXX0XXXXXXXXXXXXXXXXX VMS not connected XXXXXX1XXXXXXXXXXXXXXXXX VMS connected XXXXXXX0XXXXXXXXXXXXXXXXX in-line valve not connected XXXXXXX1XXXXXXXXXXXXXXXXX in-line valve connected XXXXXXXX0XXXXXXXXXXXXXXXXX coolant valve not connected XXXXXXXX1XXXXXXXXXXXXXXXXX coolant valve connected XXXXXXXXX0XXXXXXXXXXXXXXXXX venting valve not connected XXXXXXXXX1XXXXXXXXXXXXXXXXX venting valve connected XXXXXXXXXX0XXXXXXXXXXXXXXXXX fault indicator not connected XXXXXXXXXX1XXXXXXXXXXXXXXXXX fault indicator connected XXXXXXXXXX0XXXXXXXXXXXXXXXXX level sensor not connected XXXXXXXXXX1XXXXXXXXXXXXXXXXX level sensor connected XXXXXXXXXX0XXXXXXXXXXXXXXXXX remote module not connected XXXXXXXXXX1XXXXXXXXXXXXXXXXX remote module connected XXXXXXXXXX0XXXXXXXXXXXXXXXXXyXX y: 1.....9: sensor number XXXXXXXXXX0XXXXXXXXXXXXXXXXXyX y: 1.....9: sensor quantity XXXXXXXXXX0XXXXXXXXXXXXXXXXX remote operation off XXXXXXXXXX1XXXXXXXXXXXXXXXXX remote operation on	

Command	Operation	Response	Description
IN_STAT	status process control	0XXXXXX 1XXXXXX X0XXXXX X1XXXXX XX0XXX XX1XXX XXX0XX XXX1XX XXXX0X XXXX1X XXXX2X XXXX3X XXXX4X XXXX5X XXXXX0 XXXXX1 XXXXX2 XXXXX3	pump off pump on in-line valve closed in-line valve open coolant valve closed coolant valve open venting valve closed venting valve open VACUU•LAN Pump down Vac control Auto mode Program measuring device control off pump down - determining boiling point set vacuum reached - boiling pressure found current pressure below set vacuum - automatic switch-off
IN_ERR	fault status	0XXXXXXXX 1XXXXXXXX X0XXXXXXXX X1XXXXXXXX XX0XXXXXXXX XX1XXXXXXXX XXX0XXXXXX XXX1XXXXXX XXXX0XXXX XXXX1XXXX XXXXX0XXX XXXXX1XXX XXXXXX0XX XXXXXX1XX XXXXXX0X XXXXXX1X XXXXXX0 XXXXXX1	no fault at pump fault at pump no fault at in-line valve fault at in-line valve no fault at coolant valve fault at coolant valve no fault at venting valve fault at venting valve no overpressure overpressure no fault at pressure transducer fault at pressure transducer no external fault external fault catchpot not full catchpot full last interface command correct last interface command incorrect
IN_SP_1	set vacuum	XXXX mbar/Torr/hPa	unit according to preselections
IN_SP_2	maximum speed	XXX%	speed in % (1-100% or "HI")
IN_SP_3	switching pressure	XXXX mbar/Torr/hPa	switching pressure for VACUU•LAN or two point control; unit according to preselections

Command	Operation	Response	Description
IN_SP_4	delay	XX:XX h:m	hours:minutes (00:00 = Off)
IN_SP_5	switch off pressure	XXXX mbar/Torr/hPa	"Maximum" for "Vac control", "Minimum" for "Pump down") unit according to preselections
IN_SP_6	runtime	XX:XX h:m	process runtime (hours:minutes)
IN_SP_P1y	time	XX:XX:XX h:m:s	time in program step y (0.....9) (hours:minutes:seconds)
IN_SP_P2y	pressure	XXXX mbar/Torr/hPa	pressure in program step y (0.....9) unit according to preselections
IN_SP_P3y	venting valve	0 1	no venting valve in program step y (0.....9) venting valve in program step y (0.....9)
IN_SP_P4y	Step	0 1	no "Step" in program step y (0.....9) "Step" in program step y (0.....9)
IN_SP_P5y	Auto	0 1	no "Auto" in program step y (0.....9) "Auto" in program step y (0.....9)
IN_PV_Sx	current pressure of pressure transducer x	XXXX mbar/hPa/Torr	pressure of pressure transducer x (order of numbering according to display in "Sensors" menu)
IN_VER	version	CVC 3000 VX.XX	software version

Write commands "CVC 3000"

Command	Operation	Parameter	Description
OUT_MODE	function	0 1 2 3 30 31 32 4	VACUU•LAN Pump down Vac control Auto mode <i>optional: sensitivity: low</i> <i>optional: sensitivity: normal</i> <i>optional: sensitivity: high</i> Program
OUT_CFG	configuration (bus monitoring)	yXXX X0XX X1XX X2XX XX0X XX1X XXX0 XXX1	y: 0.....D: language+ (hexadecimal), see "Read commands CVC 3000" pressure unit mbar pressure unit Torr pressure unit hPa Autostart off Autostart on acoustic signal off acoustic signal on

Attention (OUT_MODE): If control is running, it is only possible to switch either from 1 to 2, or from 2 to 3, or from 3 to 2. The set vacuum is adopted in each case.

Command	Operation	Parameter	Description
OUT-SP_1	set vacuum	XXXX	unit according to preselection; see respective function for parameter range
OUT_SP_V	set vacuum with venting	XXXX	unit according to preselection; see respective function for parameter range
OUT_SP_2	speed	XXX	speed in % or "HI"
OUT_SP_3	start-up pressure	XXXX	unit according to preselection; see respective function for parameter range
OUT_SP_4	delay	XX:XX	hh:mm (hours:minutes)
OUT_SP_5	switch-off pressure	XXXX	unit according to preselection; see respective function for parameter range
OUT_SP_6	switch-off time	XX:XX	hh:mm (hours:minutes)
OUT_SP_PL	open program	X	program 0.....9
OUT_SP_PS	store program	X	program 0.....9
OUT_SP_P1y	time	XX:XX:XX +XX:XX:XX	total runtime until program step y (0.....9) or time for program step y (0.....9) (additive)
OUT_SP_P2y	pressure	XXXX	pressure at program step y (0.....9) unit according to preselection
OUT_SP_P3y	venting valve	0 1	no venting valve in program step y (0...9) venting valve in program step y (0.....9)
OUT_SP_P4y	Step	0 1	no "Step" in program step y (0.....9) "Step" in program step y (0.....9)
OUT_SP_P5y	Auto	0 1 2	no "Auto" in program step y (0.....9) "Auto↓" in program step y (0.....9) "Auto←" in program step y (0.....9)
START		1	started
STOP		0 1 2	Stop and delete fault Stop Stop and adopt the set vacuum
REMOTE*		0 1	Remote off Remote on
ECHO**		0 1	Echo off Echo on, write command with return value
CVC		2 3	CVC 2000 commands CVC 3000 commands***
OUT_VENT		0 1 2	venting valve closed venting valve open venting until atmospheric pressure (788 Torr (1050 mbar) at maximum)
STORE			store settings permanently, if "ECHO = 1" after realization

Command	Operation	Parameter	Description
OUT_SENSOR		1 2...9	internal sensor external sensors (if connected)

- * If remote operation is selected or deselected, the user has to ensure that no dangerous status of the system can occur due to the change of the mode of operation, and must also take appropriate safety precautions, especially if selecting remote operation interferes with a locally operated active process.
- ** With command "ECHO 1" a return value can be activated at write commands. A return value is only given if the command is performed correctly.
- *** After being switched on, the controller is in "CVC 2" mode by default. Send "CVC 3" and "STORE" to permanently set the controller RS 232C commands to the extended set "CVC 3000".

Accessories

External pressure transducer VSK 3000 ,	636657
capacitive, ceramic diaphragm sensor 1080-0.1 mbar	
Small flange connection KF DN 16	699939
Coolant valve VKW-B , 24 V=	674220
Venting valve VBM-B / KF 16 , 24 V=	674217
Level sensor	699908
VACUU•BUS Y-type adapter	636656
VACUU•BUS extension cable , 6.6ft (2m).....	612552
VACUU•BUS wall jack	636153
Serial cable RS 232C , 9-pin, Sub-D.....	637837
Upgrade kit emission condenser	699922
(for PC 3001 VARIO ^{pro} without emission condenser)	
Silencer (with connection hose).....	636588

Attention: Dust-laden gases, deposits and condensed solvent vapor can restrict air flow out the silencer. The resultant back pressure can lead to damage of pump bearings, diaphragms, and valves. Under those conditions, a silencer must not be used.

Spare parts:

Catchpot 0.52 qt (500 ml), coated	638497
--	---------------

Troubleshooting

Fault	Possible cause	Remedy
<input type="checkbox"/> No display.	<ul style="list-style-type: none"> ➔ Electrical power cord not plugged in, electrical supply failure? ➔ Controller CVC 3000 or pumping unit switched off? ➔ VACUU • BUS cable between pump and controller not plugged in at controller? ➔ Other than above mentioned causes? 	<ul style="list-style-type: none"> ✓ Plug in power cord. Check fuse. ✓ Switch on controller and/or pumping unit. ✓ Plug in VACUU • BUS cable at CVC 3000 controller. ✓ Contact local distributor.
<input type="checkbox"/> Display disappears.	<ul style="list-style-type: none"> ➔ Too much load (e.g., valves) connected? ➔ Short circuit at connected valves? ➔ Short circuit at the RS 232 plug? ➔ Other than above mentioned causes? 	<ul style="list-style-type: none"> ✓ Check current draw of the connected devices. ✓ Replace valves. ✓ Check plug and cable. ✓ Contact local distributor.
<input type="checkbox"/> Pressure reading incorrect.	<ul style="list-style-type: none"> ➔ Pressure transducer decalibrated? ➔ Humidity in the measurement chamber? ➔ Pressure transducer contaminated? ➔ Other than above mentioned causes? 	<ul style="list-style-type: none"> ✓ Readjust CVC 3000. ✓ Let the pressure transducer dry, e.g., by pumping. Readjust if necessary. Determine and eliminate the cause for humidity. ✓ See "Cleaning the pressure transducer". ✓ Contact local distributor.
<input type="checkbox"/> Digital pressure reading is flashing, display shows "0.0".	<ul style="list-style-type: none"> ➔ Pressure transducer not correctly adjusted under vacuum? 	<ul style="list-style-type: none"> ✓ Adjust CVC 3000 correctly.
<input type="checkbox"/> No digital pressure reading.	<ul style="list-style-type: none"> ➔ Pressure transducer defective? 	<ul style="list-style-type: none"> ✓ Contact local distributor.

Fault	Possible cause	Remedy
<input type="checkbox"/> Digital pressure reading is flashing, one blip*.	➔ Overpressure at the pressure transducer, pressure > 795 Torr (1060 mbar)? 	✓ Release pressure immediately (risk of bursting).
<input type="checkbox"/> Warning triangle and black valve symbol are flashing, two blips*.	➔ External venting valve removed or defective?	✓ Connect valve or replace with a new one or reconfigure without valve.
<input type="checkbox"/> Warning triangle and valve symbol are flashing, three blips*.	➔ Pump and in-line valve connected?	✓ Disconnect in-line valve; switch controller off/on to reconfigure.
<input type="checkbox"/> Warning triangle and coolant valve symbol are flashing, four blips*.	➔ Coolant valve removed or defective?	✓ Check connection cable of the valve; or use new valve or reconfigure without valve.
<input type="checkbox"/> No digital pressure reading. Warning triangle is flashing, five or seven blips*.	➔ Five blips: External pressure transducer defective or removed? ➔ Seven blips: Internal pressure transducer defective?	✓ Connect pressure transducer or replace with a new one or reconfigure without pressure transducer. ✓ Contact local distributor.
<input type="checkbox"/> Warning triangle and pump symbol are flashing, six blips*.	➔ Pump and VMS** (Vacuum Management System) connected? ➔ Fault at the VARIO pump or at the VMS? ➔ Connecting cable from pump or VMS removed?	✓ Remove VMS. Restart controller. ✓ Check pump and/or VMS, restart controller. ✓ Check cable connections.
<input type="checkbox"/> Clock symbol is flashing.	➔ Preselected process time is over?	✓ Confirm by pressing START/STOP key.
<input type="checkbox"/> Internal venting valve does not respond, valve symbol is not displayed.	➔ External pressure transducer connected and active?	✓ Select internal pressure transducer or connect external venting valve.
<input type="checkbox"/> Venting valve does not respond, valve symbol is displayed.	➔ Venting valve contaminated?	✓ Clean valve.

Fault	Possible cause	Remedy
<input type="checkbox"/> "Vac control" function: Control stops, "arrow up" is flashing.	➔ Preset maximum pressure exceeded?	✓ Confirm by pressing START/STOP key. Change maximum pressure value if necessary.
<input type="checkbox"/> "Pump down" function: Control stops, "arrow down" is flashing.	➔ Pressure below preset minimum pressure?	✓ Confirm by pressing START/STOP key. Change minimum pressure value if necessary.
<input type="checkbox"/> No function is displayed. No menu.	➔ No controllable device (valve, VARIO pump, VMS) connected?	✓ Connect devices or use controller as measuring device.
<input type="checkbox"/> Controller does not respond when pressing keys (except ON/OFF). PC symbol is displayed.	➔ Controller in remote mode?	✓ Control CVC 3000 via interface or switch off remote mode.
<input type="checkbox"/> Controller does not respond when operating any keys. No change after switching off/on.		✓ Contact local distributor.
<input type="checkbox"/> Pump does not start or stops immediately. Warning triangle and pump symbol are flashing.	➔ Pump has been exposed to condensate? ➔ Overpressure in outlet line?	✓ Allow pump to run for some minutes at maximum speed with atmospheric pressure at the inlet. ✓ Remove blockage in line, open valve.
<input type="checkbox"/> Pump does not achieve its ultimate vacuum or usual pumping speed.	➔ Centring ring at small flange connection not correctly positioned, or leak in the pipeline or vacuum system? ➔ Wrong setting at controller? ➔ Long, narrow vacuum line? ➔ Pump has been exposed to condensate?	✓ Check pump directly, then check connection, pipeline and vacuum system if necessary. ✓ Select function "Pump down" with speed set to "HI" and check again. ✓ Use lines with larger diameter, length as short as possible. ✓ Allow pump to run for some minutes with atmospheric pressure at the inlet to purge.

Fault	Possible cause	Remedy
<input type="checkbox"/> Pump does not achieve its ultimate vacuum or usual pumping speed.	<ul style="list-style-type: none"> ➔ Deposits have been formed inside the pump? ➔ Diaphragms or valves damaged? ➔ Outgassing substances or vapor generated in the process? ➔ Pressure below "Minimum" in Auto mode? ➔ Pump too hot? 	<ul style="list-style-type: none"> ✓ Clean and inspect the pump heads. ✓ Replace diaphragms and/or valves. ✓ Check process parameters. ✓ Change switch off pressure ("Minimum") if necessary. ✓ Allow pump to cool down. Determine and eliminate the cause of overheating.
<input type="checkbox"/> Pump too noisy.	<ul style="list-style-type: none"> ➔ Atmospheric or high pressure at the pump inlet? ➔ Diaphragm crack or diaphragm clamping disc loose? ➔ Other than above mentioned causes? 	<ul style="list-style-type: none"> ✓ Connect hose or silencer to pump outlet. Be careful not to cause outlet overpressure, especially with condensable vapors. ✓ Perform maintenance. ✓ Contact local distributor.
<input type="checkbox"/> Pump seized.		<ul style="list-style-type: none"> ✓ Contact local distributor.

* only if "Sound" "On" is selected

** VMS: Vacuum management system to switch non-VARIO pumps

Note: All error messages comprising a flashing warning triangle have to be confirmed (deleted) by pressing the START/STOP key.

Solve the problem (see "Remedy"), then press the START/STOP key to delete the error message.

➔ A service manual with exploded view drawings, spare parts list and directions for repair is available on request.

👉 The service manual is intended for trained service people only.

Replacing diaphragms and valves

☞ Please read section "Replacing diaphragms and valves" completely before starting maintenance.

The pictures may show other versions of pumps. This does not change the method of replacing diaphragms and valves.

DANGER

➔ Never operate the pump if covers or other parts of the pump are disassembled.



➔ Before starting maintenance, **disconnect the electrical power cord. Wait two minutes** after isolating the equipment from AC power to allow the capacitors to discharge.

➔ Ensure that the pump cannot be operated accidentally.

➔ **Note:** The pump might be contaminated with the process chemicals that have been pumped during operation. Ensure that the pump is decontaminated before maintenance.

➔ Avoid the release of pollutants.

WARNING

☞ Never operate a defective or damaged pump.

☞ Take adequate precautions to protect people from the effects of dangerous substances that may have contaminated the pump and may be released upon disassembly. Ensure that the maintenance technician is familiar with the safety procedures which relate to the products processed by the pumping system.

Use appropriate protective clothing, safety goggles and protective gloves.

☞ Allow sufficient cooling of the pump before starting maintenance.

☞ **Vent the pump and isolate it from the vacuum system before you start maintenance.**

NOTICE

Ensure that maintenance is done only by suitably trained and supervised technicians.

The valves and diaphragms are wear parts. If the rated ultimate vacuum is no longer achieved or in case of increased noise level, the pump interior, the diaphragms and the valves must be cleaned and the diaphragms and valves must be checked for cracks or other damage.

All bearings are encapsulated and are filled with long-life lubricant. Under normal operating conditions, the drive system is maintenance free.

In demanding circumstances, it may be efficient to check and clean the pump heads on a regular basis. In normal use, the lifetime of the diaphragms and valves is more than 10,000 operating hours.

- Prevent internal condensation, transfer of liquids or dust. The diaphragms and valves will be damaged if liquid is pumped in significant amount.
- Carry out maintenance frequently if the pump is exposed to corrosive media or in case of deposits.
- Regular maintenance will improve the lifetime of the pump and also protect both users and the environment.

Service kit MD 1C (diaphragms, valves, diaphragm key) **696828**

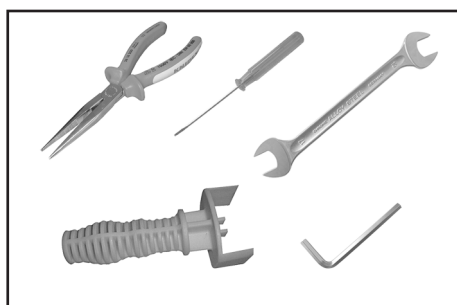
**Tools required (metric):**

- Diaphragm key width 46 mm
- Open end wrench width 14 / 17 mm
- 4 / 5 mm wide Allen key
- 2.5 mm wide slotted screwdriver
- Phillips screwdriver size 2
- Torx driver T10
- Flat pliers

Cleaning and inspecting the pump heads

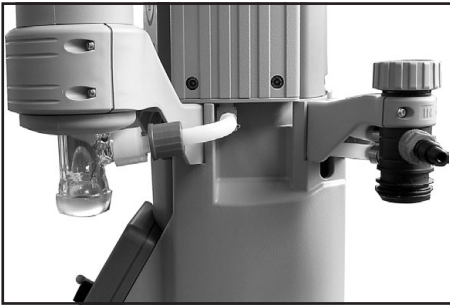

- ➔ Remove catchpots (10) at inlet and outlet (see „Use and operation“, pg. 38).

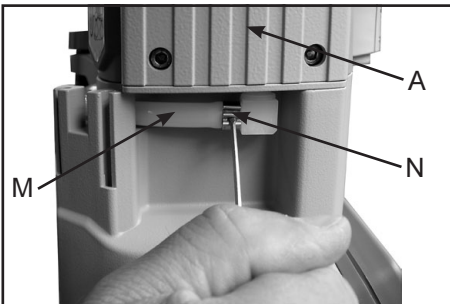

Detach the coupling of the hose connection (M) below the housing cover (A).

- ➔ Open the hose clip (N) with a slotted screwdriver.
- ➔ Pull the tubing off the hose connector.

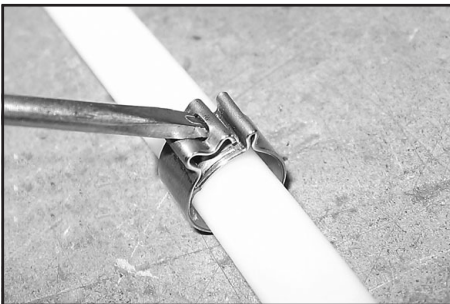

Opening the hose clip:

- ➔ Apply slotted screwdriver as shown and turn.

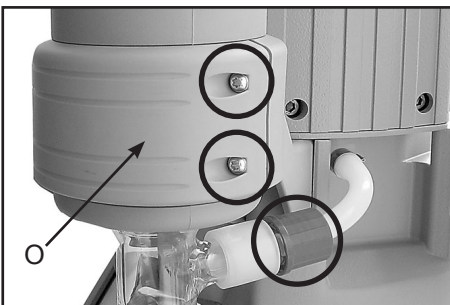

PC 3001 VARIO^{pro} / PC 3001 VARIO^{pro} IK

Disassemble the exhaust vapor condenser.

- ➔ Loosen the union nut at the inlet of the exhaust vapor condenser.
- ➔ Remove the 4 screws affixing the counter holder (O) of the exhaust vapor condenser with a Torx driver T10.
- ➔ Remove the exhaust vapor condenser. In doing so pull the PTFE hose out of the inlet of the exhaust vapor condenser.



PC 3001 VARIO^{pro} IK

Disassemble the inlet condenser.

- Loosen the union nut at the inlet of the pump.
- Remove the 4 screws affixing the counter holder of the exhaust vapor condenser with a Torx driver T10.
- Remove the inlet condenser. In doing so pull the PTFE hose out of the inlet of the inlet condenser.



PC 3001 VARIO^{pro} TE

Disassemble the emission condenser TE.

- Loosen the union nut at the inlet of the emission condenser TE.
- Remove the 2 screws affixing the mounting plate of the emission condenser TE with a Phillips screw driver size 2.
- Remove the emission condenser TE. In doing so pull the PTFE hose out of the inlet of the emission condenser TE.



PC 3001 VARIO^{pro} EK Peltronic

Disassemble the Peltronic emission condenser. Detach the coupling of the hose connection at the Peltronic emission condenser.

- Open the hose clip with a slotted screwdriver.
- Pull the tubing off the hose connector.
- Remove the 2 screws affixing the mounting plate of the Peltronic emission condenser with a Phillips screw driver size 2.
- Remove the Peltronic emission condenser. In doing so pull the PTFE hose out of the inlet of the Peltronic emission condenser.

☞ Service only one side of the pump at a time to avoid the mixing of parts.

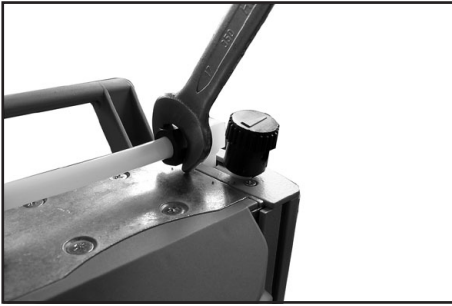

- ➔ Loosen the union nut (K) of the hose connection next to the gas ballast valve with an open-ended wrench (w/f 17).



- ➔ Turn the fitting (L) with an open-ended wrench (w/f 14) to detach the hose from the pump head (1/4 of a turn at maximum).
- ⚠ Do not remove the elbow fitting from the pump head; during reassembly a leak may result.

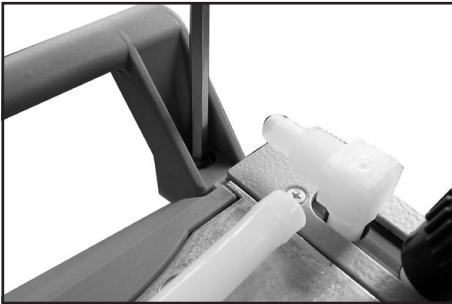

- ➔ Loosen the screw affixing the handle (use 5 mm wide Allen key) at one housing cover.

Disassembling the housing cover at the side of the emission condenser



- ➔ Lay the pumping unit on its side with the pump heads to be maintained at the top. Support the pumping unit appropriately.
- ➔ Disassemble the housing cover (A) to check the valves (B).
- ➔ Unscrew six Allen screws with a 4mm wide Allen key. Remove the housing cover with housing cover insert (A) together with head covers (C) and valves (B).
- ⚠ Never use a pointed or sharp-edged tool to remove parts (e.g., screwdriver). We recommend using a rubber mallet or compressed air (to be blown carefully into port).

View of the disassembled pump head parts

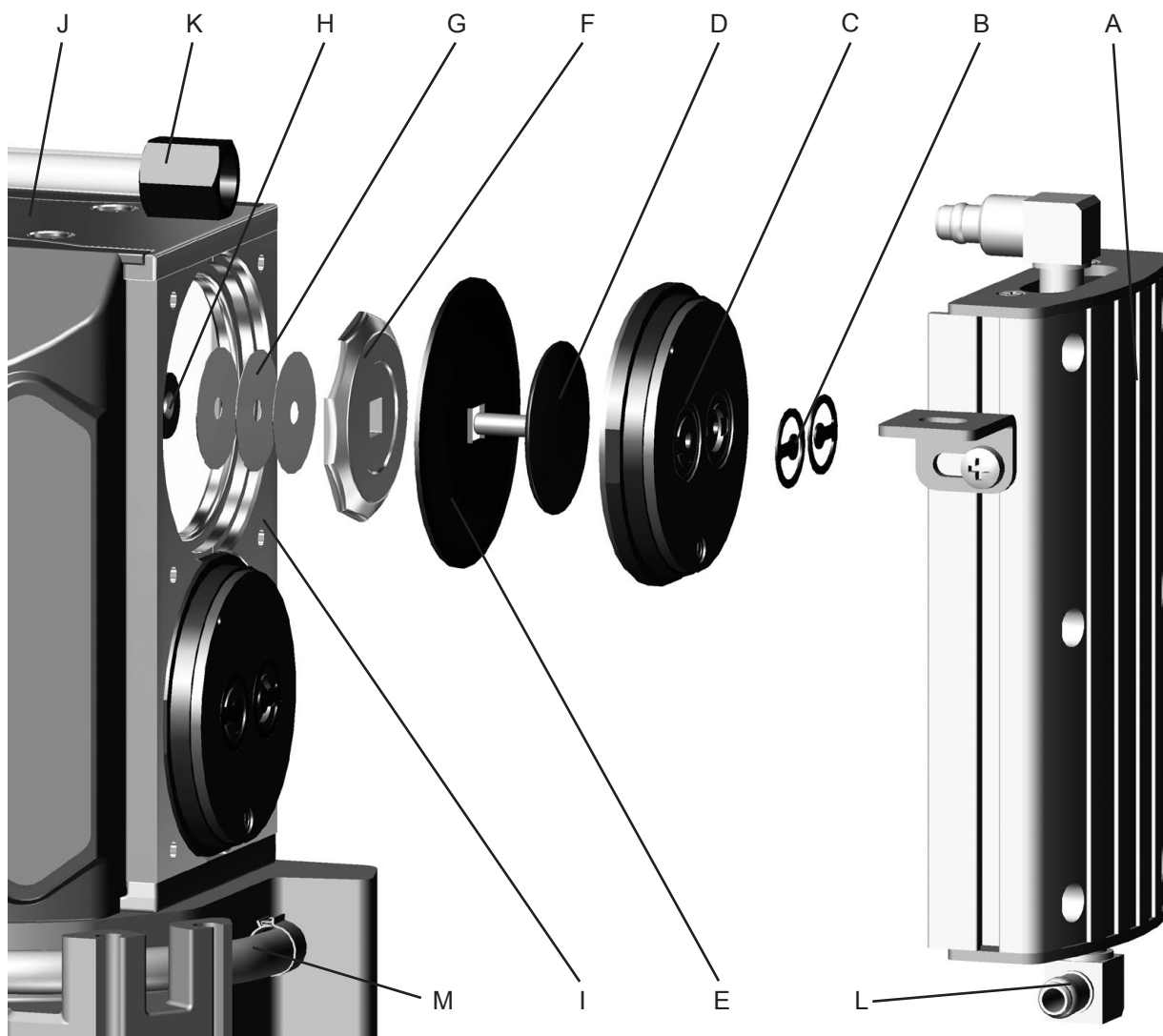

Pump head parts:

A: Housing cover with insert
 B: Valves
 C: Head cover
 D: Diaphragm clamping disc
 with square head screw
 E: Diaphragm
 F: Diaphragm support disc

G: Washer(s)
 H: Connecting rod
 I: Housing
 J: Housing bearing flange
 K: Union nut
 L: Fitting
 M: Hose connection



- ➔ Remove the head cover (C) carefully from the housing cover (A). Note position and alignment of valves (B). Remove the valves.
- ☞ Replace valves if necessary.
- ☞ Use petroleum ether or other industrial solvent to remove deposits. Do not inhale vapors.

Replacing the diaphragm

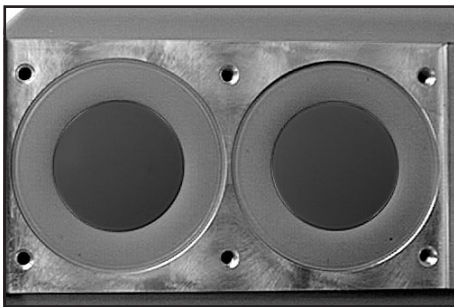

- ☞ Check diaphragms (E) for damage and replace if necessary.

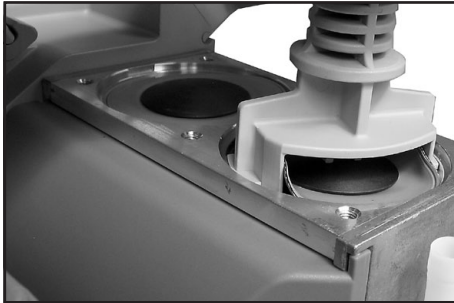

- ➔ Lift diaphragm carefully sidewise.
- ☞ Never use a pointed or sharp-edged tool to lift the diaphragm. If necessary, press down the diaphragm clamping disc of the adjacent pump head to raise the diaphragm into its uppermost turning point position.
- ➔ Use the diaphragm key to grip the diaphragm support disc (F) below the diaphragm.
- ➔ Press down the diaphragm clamping disc to bring the diaphragm into its lower turning point position. Unscrew diaphragm support disc (F) with diaphragm (E) and diaphragm clamping disc (D).
- ➔ Check for washers (G) between the diaphragm support disc (F) and the connecting rod (H). Do not mix the washers from the different pump heads, since these are set at the factory to ensure proper pump performance. Make sure that the original number is reassembled at the individual pump head.
- ☞ Too few washers: The pump will not attain vacuum specification. Too many washers: Diaphragm clamping disc will hit head cover, causing noisy operation and possibly causing the pump to seize up.

- ☞ If the old diaphragm is difficult to separate from the diaphragm support disc, immerse assembly in naphtha or petroleum ether. Do not inhale vapors!

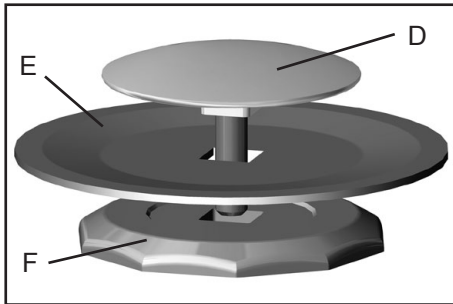

- ➔ Position new diaphragm (E) between diaphragm clamping disc with square head screw (D) and diaphragm support disc (F).
- ☞ **Note:** Position diaphragm with pale side towards diaphragm clamping disc (facing pump chamber).

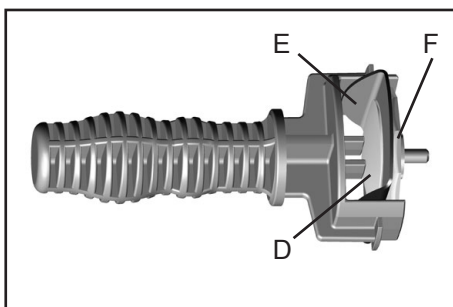

- ☞ Make sure that the square head screw of the diaphragm clamping disc is correctly seated in the guide hole of the diaphragm support disc.
- ➔ Lift the diaphragm at the side. Place the diaphragm carefully together with diaphragm clamping disc and diaphragm support disc in the diaphragm key.
- ☞ Avoid damage of the diaphragm: Do not excessively bend or crease the diaphragm.

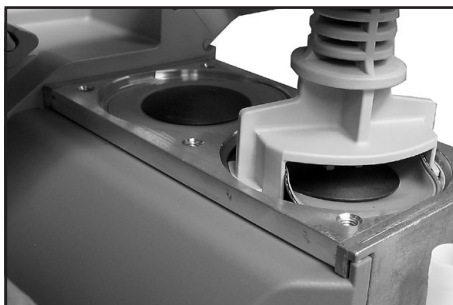

- ☞ Assemble the original number of washers (G) between diaphragm support disc (F) and connecting rod (H).
- ➔ Screw diaphragm clamping disc (D), diaphragm (E), diaphragm support disc (F), and washers (G) to connecting rod (H).

- ➔ Optimum torque for the diaphragm support disc: 3 ft·lb_f (4 Nm).
- ☞ If necessary, put the pumping unit in its upright position to screw the diaphragm clamping disc to the connecting rod. Subsequently lay the pumping unit again on its side.

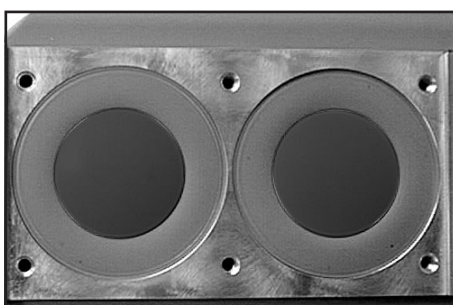

- ➔ Bring the diaphragms (E) into a position, in which they are in contact with the housing (I) and centered with respect to the bore.

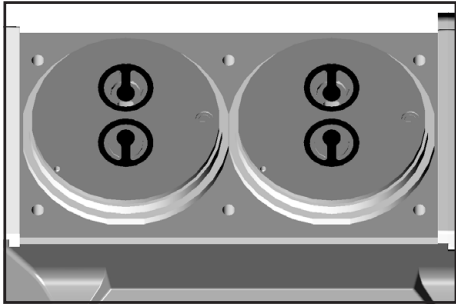

- ➡ Put on head covers (C).
- ☞ Pay attention to the correct orientation of the head covers (see figure below).
- ☞ Make sure that the diaphragms stay centered with respect to the bores so that they will become clamped uniformly between housing (I) and head covers (C).

- ➡ Put the valves (B) in place. See figure below for the correct position of the valves:

Inlet side of pump head: The valve tongue points at the kidney-shaped orifice in the valve seat (1).

Outlet side of pump head: The valve is oriented the opposite direction as the valve at the inlet side. Round orifice under the valve tongue (2).

Scheme of pump heads with head covers and valves

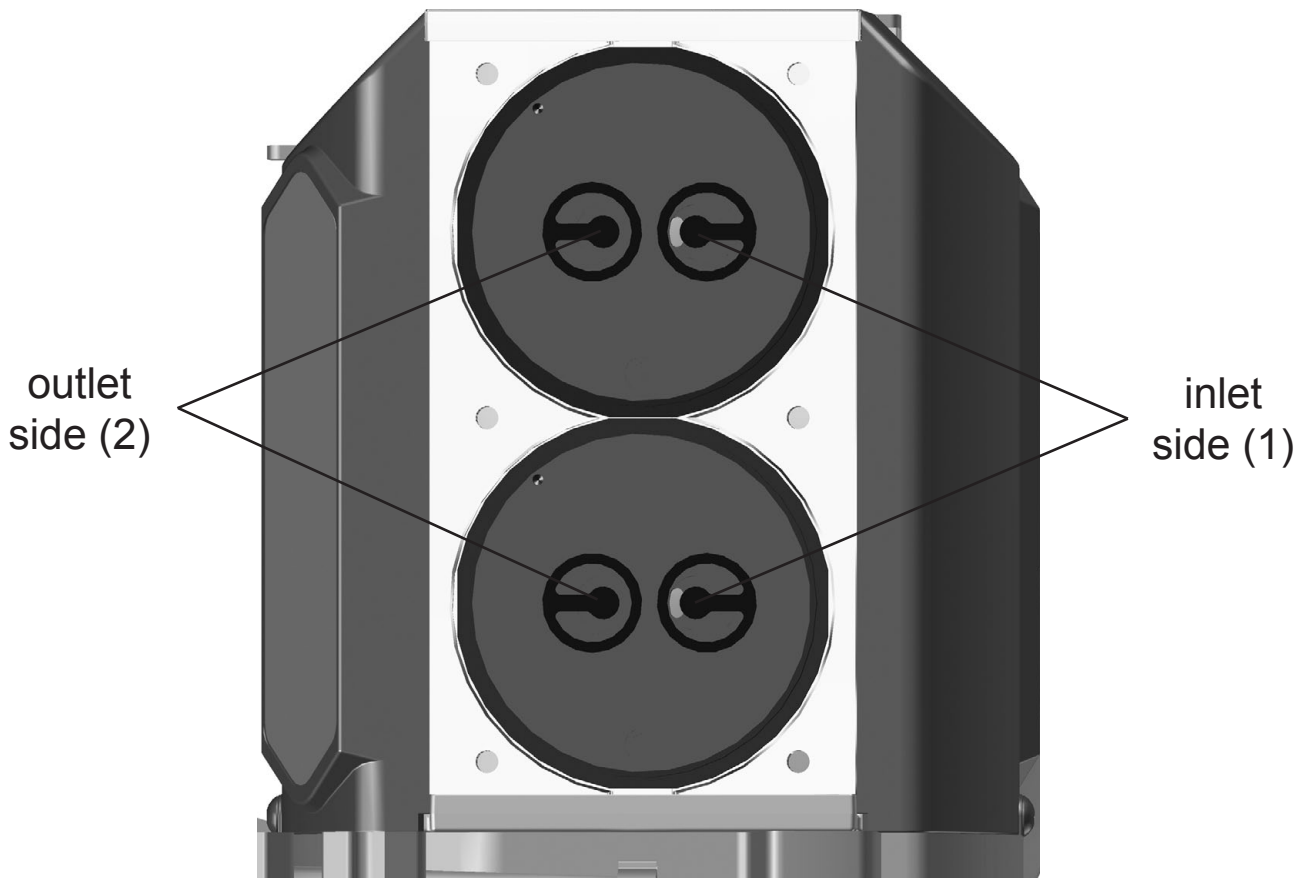

Assembling the housing cover at the side of the emission condenser

- ➔ Put on housing cover (A).
- ☞ Move housing cover slightly to ensure that the head covers are correctly positioned.

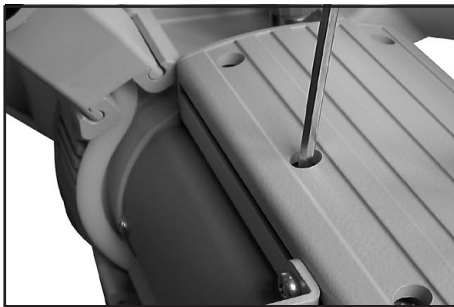

- ➔ Screw in the Allen head screws at the head cover in a diagonal pattern with a 4 mm wide Allen key, loosely at first, to align, then tighten.
- ☞ Maximum torque: 4.4 ft·lb_f (6 Nm).

Disassembling the housing cover at the side of the ON/OFF switch

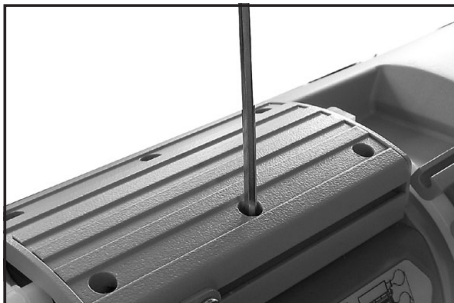

- ➔ Lay the pumping unit on its side with the pump heads to be maintained at the top. Support the pumping unit appropriately.
 - ➔ Disassemble the housing cover (A) to check the valves (B).
 - ➔ Unscrew six Allen screws with a 4mm wide Allen key. Remove the housing cover with housing cover insert (A) together with head covers (C) and valves (B).
- ☞ Never use a pointed or sharp-edged tool to remove parts (e.g., screwdriver). We recommend using a rubber mallet or compressed air (to be blown carefully into port).



- ➔ Remove the head cover (C) carefully from the housing cover (A). Note position and alignment of valves (B). Remove the valves.
- ☞ Replace valves if necessary.
- ☞ Use petroleum ether or other industrial solvent to remove deposits. Do not inhale vapors.

For replacing the diaphragm refer to the section "Replacing the diaphragm" above.

Assembling the housing cover at the side of the ON/OFF switch

- ➔ Put on housing cover (A).
Pay attention to a correct guidance of the connection hose towards the inlet.
- ☞ Move housing cover slightly to ensure that the head covers are correctly positioned.

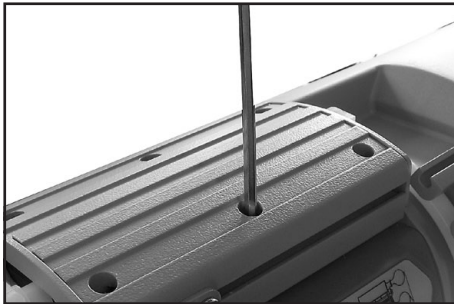

- ➔ Screw in the Allen head screws at the head cover in a diagonal pattern with a 4 mm wide Allen key, loosely at first, to align, then tighten.
- ☞ Maximum torque: 4.4 ft·lb_f (6 Nm).

Assembling the fittings

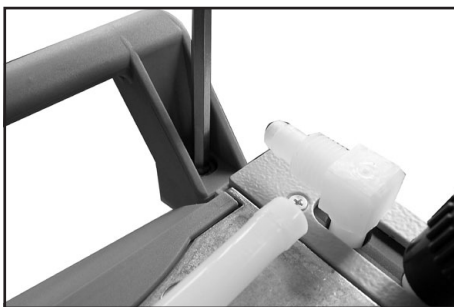

- ➔ Attach the handle at the housing cover (use 5 mm wide Allen key)



- ➔ Slip the hose onto the hose connector by turning the fitting (L) with an open-ended wrench w/f 14.

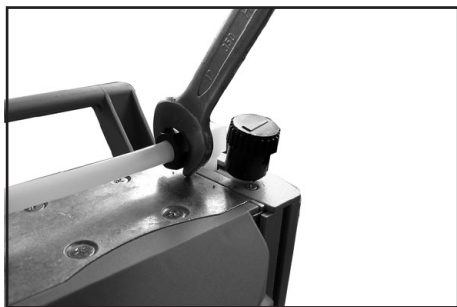

- ➔ Tighten the union nut (K) of the hose connection with an open-ended wrench w/f 17.
- ☞ Tighten the union nut first by hand and then tighten one full turn using the open ended wrench.



PC 3001 VARIO^{pro} / PC 3001 VARIO^{pro} IK

Assemble the exhaust vapor condenser.

- ➔ Feed the PTFE hose from the pump outlet into the inlet of the exhaust vapor condenser.
- ➔ Mount the condenser with the counter holder (Torx screws T10) to the pump.
- ➔ Fasten union nut.



PC 3001 VARIO^{pro} IK

Assemble the inlet condenser.

- ➔ Slip the hose from the inlet of the pump onto the hose connector of the inlet condenser.
- ➔ Mount the condenser with the counter holder (Torx screws T10) to the pump.
- ➔ Tighten the union nut first by hand and then tighten one full turn using the open ended wrench.



PC 3001 VARIO^{pro} TE

Assemble the emission condenser TE.

- ➔ Feed the PTFE hose from the pump outlet into the inlet of the emission condenser TE.
- ➔ Attach the mounting plate of the emission condenser TE with 2 screws at the housing cover of the pumping unit; use a Phillips screw driver size 2. Pay attention to the cage nuts in the groove of the housing cover.
- ➔ Fasten union nut.



PC 3001 VARIO^{pro} EK Peltronic

Assemble the emission condenser Peltronic.

- Slip the hose from the outlet of the pump onto the hose connector of the emission condenser Peltronic.
- Attach the hose connection with hose clip. Close hose clip with flat pliers.
- Attach the mounting plate of the emission condenser Peltronic with 2 screws at the housing cover of the pumping unit; use a Phillips screw driver size 2. Pay attention to the cage nuts in the groove of the housing cover.



- Slip connecting hose onto hose connection of fitting below the housing cover.
- Close hose clip with flat pliers.



- Assemble catchpots (10) with joint clips.

Checking the ultimate vacuum

- After any intervention at the equipment (e.g., repair / maintenance) the ultimate vacuum of the pump has to be checked. Only if the pump achieves its specified ultimate vacuum, the pump's leak rate is low enough to ensure that no explosive atmospheres will occur in the interior of the equipment.

After any intervention at the vacuum sensor the leak rate of the equipment has to be checked.

If the pump does not achieve the ultimate vacuum:

- Whenever the diaphragms and valves have been replaced, a break-in period of several hours is required before the pump achieves its ultimate vacuum.
- In case of an unusual noise, switch off pump immediately and check clamping disc positions.

If the specified ultimate vacuum is not achieved, and if this does not change after the break-in period:

Check hose connectors at pump heads for leaks. If necessary recheck valve seats and pump chambers.

Cleaning and replacing components

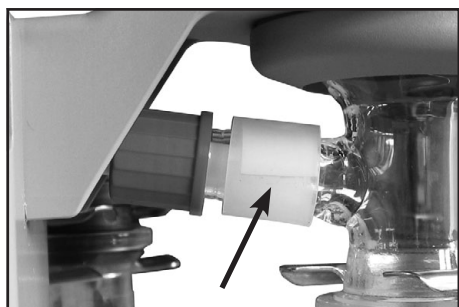

Overpressure safety relief device **638821**
(at exhaust waste vapor condenser)

Replacing the overpressure safety relief device:

- Loosen the union nut at the inlet of the exhaust vapor condenser.
- Pull the PTFE hose out of the inlet of the exhaust vapor condenser.
- If necessary, pull off the old pressure relief valve and install the new one. Check for correct position of the PTFE-film under the pressure relief valve.
- Feed the PTFE hose into the inlet of the exhaust vapor condenser. Fasten union nut.

Catchpot

0.52 qt (500 ml), coated..... **638497**

O-ring 28 x 2.5 **3120553**

(FPM) at the spherical ground joint of the catchpot at the inlet

O-ring 28 x 2.5 **638304**

FEP bonded for increased chemical resistance

Notes on return to the factory

Repair - return - DAkkS calibration

NOTICE

Safety and health of our staff, laws and regulations regarding the handling of dangerous goods, occupational health and safety regulations and regulations regarding safe disposal of waste require that for all pumps and other products, the „Health and safety clearance form“, pg. 117, must be sent to our office fully completed and signed before any equipment is shipped to the authorized service center.

Fax or mail a completed copy of the health and safety clearance form to us in advance. The declaration must arrive before the equipment. **Enclose a second completed copy with the product.** If the equipment is contaminated, you must notify the carrier.

No repair / DAkkS calibration is possible unless the correctly completed form is returned. Inevitably, there will be a delay in processing the equipment if information is missing, or if this procedure is not followed.

CAUTION

If the product has come in contact with chemicals, radioactive substances or other substances dangerous to health or environment, the product must be decontaminated **prior to sending it back to the service center.**

- Return the product to us disassembled and cleaned and accompanied by a certificate verifying decontamination or
- Contact an industrial cleaning and **decontamination service** directly or
- Authorize us to send the product to an industrial cleaning facility **at your expense.**

To expedite repair and to reduce costs, please enclose a detailed description of the problem and the product's operating conditions with every product returned for repair

We submit **repair quotations** only on request and always at the customer's expense. If an order is placed, the costs incurred for problem diagnosis are offset from the costs for repair or from the purchase price, if the customer prefers to buy a new product instead of repairing the defective one.

- **If you do not wish a repair on the basis of our quotation, the equipment may be returned to you disassembled and at your expense.**

In many cases, the **components must be cleaned in the factory** prior to repair.

For cleaning we use an environmentally friendly water-based process. Unfortunately the combined attack of elevated temperature, cleaning agent, ultrasonic treatment and mechanical stress (from pressurized water) may result in damage to the paint. Please mark in the health and safety clearance form if you wish a **repaint at your expense** just in case such a damage should occur.

We will also replace parts for cosmetic reasons at your request and at your expense.

NOTICE

Before returning the equipment, ensure that (if applicable):

- Oil sealed pumps: Oil has been drained and an adequate quantity of fresh oil has been filled in to protect against corrosion. Dispose according to regulations.
- Equipment has been cleaned and/or decontaminated (inside and outside).
- All inlet and outlet ports have been capped.
- Equipment has been properly packed, (if necessary, please order original packaging materials at your cost), marked appropriately and the carrier has been notified of any possible contamination.
- The completed health and safety clearance form is enclosed.

We thank you in advance for your understanding of the necessity for these measures that protect our employees, and ensure that your pump is protected in shipment.

Scrapping and waste disposal:

Dispose of the equipment and any components removed from it safely in accordance with all local and national safety and environmental requirements. Particular care must be taken with components and waste oil which have been contaminated with dangerous substances from your processes. Do not incinerate fluoroelastomer seals and O-rings.

- You may authorize us to dispose of the equipment **at your expense.**

Warranty

VACUUBRAND shall be liable for insuring that this product, including any agreed installation, has been free of defects at the time of the transfer of risk.

VACUUBRAND shall not be liable for the consequences of improper handling, use, servicing or operation of this product or the consequences of normal wear and tear of wearing parts such as diaphragms, seals, valves, vanes, condensers, oil and the breakage of glass or ceramic parts, for the consequences of chemical, electrochemical or electrical influences or the failure to follow the instructions in this manual.

Claims for defects against VACUUBRAND shall be limited to one year from delivery. The same shall apply to claims for damages irrespective of legal grounds.

For further information on general terms and conditions refer to www.vacuubrand.com.

Health and safety clearance form



Devices will not be accepted for any handling before we have received this declaration. Please read and comply with "Notes on return to the factory".
Oil filled pumps: Drain oil prior to shipping absolutely!

1. Device (Model): 2. Serial no.:

3. Reason for return / malfunction:

.....

4. Has the device been used in a copper process step (e.g., semiconductor production). yes no

5. Substances (gases, liquids, solids) in contact with the device / which have been pumped:

.....

.....

.....

6. Prior to return to the factory the device has been decontaminated. yes no
Description of the decontamination method and the test / verification procedure:

.....

.....

7. The device is free of hazardous, harmful substances. yes no

8. Protective measures required for VACUUBRAND employees:

.....

9. If the paint is damaged, we wish a repaint or a replacement of parts for reason of appearance (repaint and replacement at customer's expense). yes no

10. Legally binding declaration

We assure for the returned device that all substances, which have been in contact with the device are listed in section 5 and that the information is complete and that we have not withheld any information. We declare that all measures - where applicable - have been taken listed in section "Return to the factory". By our signature below, we acknowledge that we accept liability for any damage caused by providing incomplete or incorrect information and that we shall indemnify VACUUBRAND from any claims as regards damages from third parties. We are aware that as expressed in § 823 BGB (Public Law Code of Germany) we are directly liable for injuries or damages suffered by third parties, particularly VACUUBRAND employees occupied with handling/repairing the product.
Shipping of the device must take place according to regulations.

Name: Signature:

Job title: Company's seal:

Date:

Release for repair grant by VACUUBRAND (date / signature):

VACUUBRAND GMBH + CO KG
Alfred-Zippe-Straße 4
97877 Wertheim, Germany

Tel.: +49 9342 808-5660
Fax: +49 9342 808-5666
E-Mail: service@vacuubrand.com
www.vacuubrand.com



EG-Konformitätserklärung für Maschinen
EC Declaration of Conformity of the Machinery
Déclaration CE de conformité des machines

Hersteller / Manufacturer / Fabricant:

VACUUBRAND GMBH + CO KG · Alfred-Zippe-Str. 4 · 97877 Wertheim · Germany

Hiermit erklärt der Hersteller, dass die Maschine konform ist mit den Bestimmungen der Richtlinie 2006/42/EG.

Hereby the manufacturer declares that the machinery is in conformity with the directive 2006/42/EC.

Par la présente, le fabricant déclare, que la machine est conforme à directive 2006/42/CE.

Membranvakuumpumpe / Diaphragm vacuum pump / Pompe à membrane:

Typ / Type / Type: PC 3001 VARIO^{pro} / PC 3001 TE VARIO^{pro} / PC 3001 VARIO^{pro} IK / PC 3001 VARIO^{pro} emission condenser Peltronic / PC 3001 VARIO^{pro} without emission condenser

Artikelnummer / Order number / Numéro d'article: 696700, 696701, 696702, 696703, 2613943, 2613980 / 696710, 696713 / 696745 / 696735 / 696753, 696755

Seriennummer / Serial number / Numéro de série: Siehe Typenschild / See rating plate / Voir plaque signalétique

Die Maschine ist konform mit weiteren Richtlinien / The machinery is in conformity with other directives / La machine est conforme à d'autres directives:

2006/95/EG, 2004/108/EG, 94/9/EG

Angewandte harmonisierte Normen / Harmonized standards applied / Normes harmonisées utilisées:

DIN EN 12100, DIN EN 61010-1, DIN EN 1012-2, DIN EN 61326-1, DIN EN 1127-1, EN 13463-1

Bevollmächtigter für die Zusammenstellung der technischen Unterlagen / Person authorized to compile the technical file / Personne autorisée à constituer le dossier technique:

Dr. J. Dirscherl · VACUUBRAND GMBH + CO KG · Alfred-Zippe-Str. 4 · 97877 Wertheim · Germany

Wertheim, 10.01.2012

ort, Datum / place, date / lieu, date

(Dr. F. Gitmans)

Managing director / Gérant

ppa.

(Dr. J. Dirscherl)

Technical Director / Directeur technique

VACUUBRAND GMBH + CO KG

Alfred-Zippe-Str. 4 · 97877 Wertheim

T +49 9342 808-0 · F +49 9342 808-5555

info@vacuubrand.com

www.vacuubrand.com

Certificate



Certificate no.

CU 72113298 01

License Holder:

VACUUBRAND GMBH + Co. KG
 Alfred-Zippe-Str. 4
 97877 Wertheim
 Germany

Manufacturing Plant:

VACUUBRAND GMBH + Co. KG
 Alfred-Zippe-Str. 4
 97877 Wertheim
 Germany

Test report no.: USA-JE 31183478 001

Client Reference: M. von Przychowski

Tested to:

UL 61010-1:2004 R10.08
 CAN/CSA-C22.2 NO. 61010-1-04+G11 (R2009)

Certified Product: Diaphragm Vacuum Pump for Laboratory Use

License Fee - Units

Model Designation: PC 3001 y zzz; VP 2 autovac 7
 y = VARIO, basic, VARIO TE, VARIO +IK,
 AD VARIO
 z = blank, A-Z, +, - (customer specific
 configurations)

Rated Voltage: AC 100-230V, 50/60Hz

Rated Current: 1.6A/0.7A

Protection Class: I

Appendix: 1, 1-2

Licensed Test mark:

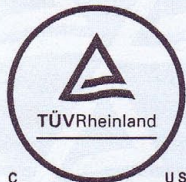

Signature

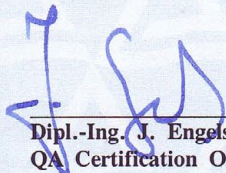
 Dipl.-Ing. J. Engels
 QA Certification Officer

Date of Issue

(day/mo/yr)
 22/12/2011

This certificate is only valid for pumps with the respective mark (Licensed Test mark) on the pump rating plate.

Disclaimer: Our technical literature is only intended to inform our customer. The applicability of general empirical values and results obtained under lab conditions to your specific operations depends on a number of factors beyond our control. It is, therefore, strictly the users' responsibility to very carefully check the application of these data to their specific requirements. No claims arising from the information provided in this literature will, consequently, be entertained.



Alfred-Zippe-Str. 4 · 97877 Wertheim / Germany
T +49 9342 808-0 · F +49 9342 808-5555
info@vacuubrand.com · www.vacuubrand.com

VACUUBRAND GMBH + CO KG
- Technology for Vacuum Systems -
© 2012 VACUUBRAND GMBH + CO KG Printed in Germany